



# USER MANUAL

# MSI200A SERIES INVERTER

**KEILRIEMEN.AT**

## Preface

Thanks for choosing our products.

MSI200A series inverters are newly-designed by our company for controlling asynchronous AC inductance motors. Applying the most advanced speedless sensor vector control technology, DSP control system, and our product enhances its reliability to meet the adaptability to the environment, customized and industrialized design with more optimized functions, more flexible application and more stable performance.

The vector control performance of MSI200A series inverters is as outstanding as that of the leading sophisticated inverters on worldwide market. Its speed and torque control can be simultaneously, comparing with the other kinds, its function of anti-trip and strong adaptability to worse grid, temperature, humidity and dust make it meet the high performance requirement of the customer application.

MSI200A series inverters apply modularized design to meet the specific demand of customers, as well as the demand of the whole industry flexibly and follow the trend of industrial application to the inverters on the premise of meeting general need of the market.

Powerful speed control, torque control, simple PLC, flexible input/output terminals, pulse frequency reference, traverse control can realize various complicate high-accuracy drives and provide integrative solution for the manufacturers of industrial devices, which contributes a lot to the cost reducing and improves reliability.

MSI200A series inverters can meet the demand of environmental protection which focuses on low noise and weakening electromagnetic interference in the application sites for the customers.

This manual provides installation and configuration, parameters setting, fault diagnoses and daily maintenance and relative precautions to customers. Please read this manual carefully before the installation to ensure a proper installation and operation and high performance of MSI200A series inverters.

Our company reserves the right to update the information of our products.

## Content

Preface .....	2
Content .....	3
1 Safety Precautions .....	7
1.1 What this chapter contains .....	7
1.2 Safety definition .....	7
1.3 Warning symbols .....	7
1.4 Safety guidelines .....	8
2 Quick Start-up .....	11
2.1 What this chapter contains .....	11
2.2 Unpacking inspection .....	11
2.3 Application confirmation .....	11
2.4 Environment .....	11
2.5 Installation confirmation .....	12
2.6 Basic commission .....	12
3 Product Overview .....	13
3.1 What this chapter contains .....	13
3.2 Basic principles .....	13
3.3 Product specification .....	14
3.4 Name plate .....	15
3.5 Type designation key .....	15
3.6 Rated specifications .....	16
3.7 Structure diagram .....	17
4 Installation Guidelines .....	19
4.1 What this chapter contains .....	19
4.2 Mechanical installation .....	19
4.3 Standard wiring .....	23
4.4 Layout protection .....	29
5 Keypad Operation Procedure .....	31
5.1 What this chapter contains .....	31
5.2 Keypad .....	31

5.3 Keypad displaying.....	33
5.4 Keypad operation.....	33
6 Function Parameters.....	35
6.1 What this chapter contains.....	35
6.2 MSI200A general series function parameters.....	35
7 Basic Operation Instruction.....	100
7.1 What this chapter contains.....	100
7.2 First powering on.....	100
7.3 Vector control.....	102
7.4 Torque control.....	103
7.5 Parameters of the motor.....	104
7.6 Start-up and stop control.....	105
7.7 Frequency setting.....	106
7.8 Simple PLC.....	107
7.9 Multi-step speed running.....	107
7.10 PID control.....	108
7.11 Pulse counter.....	110
8 Fault Tracking.....	111
8.1 What this chapter contains.....	111
8.2 Alarm and fault indications.....	111
8.3 How to reset.....	111
8.4 Fault history.....	111
8.5 Fault instruction and solution.....	111
8.6 Common fault analysis.....	115
8.6.1 The motor does not work.....	115
8.6.2 Motor vibration.....	116
8.6.3 Overvoltage.....	116
8.6.4 Undervoltage fault.....	117
8.6.5 Abnormal motor heat.....	117
8.6.6 Inverter overheating.....	118
8.6.7 Stall during the acceleration of the motor.....	118



8.6.8 Overcurrent.....	119
8.7 Inverter system interference troubleshooting.....	119
3.....	119
8.8 Maintenance and hardware diagnostics.....	120
8.8.1 Overcurrent.....	120
8.8.2 Cooling fan.....	122
8.8.3 Capacitors.....	123
8.8.4 Power cable.....	124
9 Communication Protocol.....	125
9.1 What this chapter contains.....	125
9.2 Brief instruction to MODBUS protocol.....	125
9.3 Application of the inverter.....	125
9.4 RTU command code and communication data illustration.....	129
Appendix A Technical Data.....	142
A.1 What this chapter contains.....	142
A.2 Ratings.....	142
A.3 Electric power network specification.....	143
A.4 Motor connection data.....	143
A.5 Applicable standards.....	143
A.6 EMC regulations.....	144
Appendix B Dimension Drawings.....	146
B.1 What this chapter contains.....	146
B.2 Keypad structure.....	146
B.3 Inverter chart.....	147
Appendix C Peripheral Options and Parts.....	151
C.1 What this chapter contains.....	151
C.2 Peripheral wiring.....	151
C.3 Power supply.....	152
C.4 Cables.....	152
C.5 Breaker, electromagnetic contactor and leakage protection switch.....	155

C.6 Reactors .....	157
C.7 Filters Filters selection table .....	158
C.8 Braking system .....	158
C.9 Other optional parts.....	161
Appendix D Further Information .....	163

KEILRIEMEN.AT

# 1 Safety Precautions

## 1.1 What this chapter contains

Please read this manual carefully and follow all safety precautions before moving, installing, operating and servicing the inverter. If ignored, physical injury or death may occur, or damage may occur to the devices.

If any physical injury or death or damage to the devices occurs for ignoring to the safety precautions in the manual, our company will not be responsible for any damages and we are not legally bound in any manner.

## 1.2 Safety definition

**Danger:** Serious physical injury or even death may occur if not follow relevant requirements









**Warning:** Physical injury or damage to the devices may occur if not follow relevant requirements

**Note:** Physical hurt may occur if not follow relevant requirements

**Qualified electricians:** People working on the device should take part in professional electrical and safety training, receive the certification and be familiar with all steps and requirements of installing, commissioning, operating and maintaining the device to avoid any emergency.





## 1.3 Warning symbols

Warnings caution you about conditions which can result in serious injury or death and/or damage to the equipment, and advice on how to avoid the danger. Following warning symbols are used in this manual:

Symbols	Name	Instruction	Abbreviation
 Danger	Electrical Danger	Serious physical injury or even death may occur if not follow the relative requirements	
 Warning	General danger	Physical injury or damage to the devices may occur if not follow the relative requirements	
 Do not	Electrostatic discharge	Damage to the PCBA board may occur if not follow the relative requirements	
 Hot sides	Hot sides	Sides of the device may become hot. Do not touch.	
Note	Note	Physical hurt may occur if not follow the relative requirements	Note



## 1.4 Safety guidelines

	<ul style="list-style-type: none"> <li>✧ Only qualified electricians are allowed to operate on the inverter.</li> <li>✧ Do not carry out any wiring and inspection or changing components when the power supply is applied. Ensure all input power supply is disconnected before wiring and checking and always wait for at least the time designated on the inverter or until the DC bus voltage is less than 36V. Below is the table of the waiting time:</li> </ul> <table border="1" data-bbox="258 376 957 499"> <thead> <tr> <th data-bbox="258 376 610 411">Inverter model</th> <th data-bbox="610 376 957 411">Minimum waiting time</th> </tr> </thead> <tbody> <tr> <td data-bbox="258 411 610 440">380V 1.5kW-110kW</td> <td data-bbox="610 411 957 440">5 minutes</td> </tr> <tr> <td data-bbox="258 440 610 469">380V 132 kW-315 kW</td> <td data-bbox="610 440 957 469">15 minutes</td> </tr> <tr> <td data-bbox="258 469 610 499">380V above 350 kW</td> <td data-bbox="610 469 957 499">25 minutes</td> </tr> </tbody> </table>	Inverter model	Minimum waiting time	380V 1.5kW-110kW	5 minutes	380V 132 kW-315 kW	15 minutes	380V above 350 kW	25 minutes
Inverter model	Minimum waiting time								
380V 1.5kW-110kW	5 minutes								
380V 132 kW-315 kW	15 minutes								
380V above 350 kW	25 minutes								
	<ul style="list-style-type: none"> <li>✧ Do not refit the inverter unauthorized; otherwise fire, electric shock or other injury may occur.</li> </ul>								
	<ul style="list-style-type: none"> <li>✧ The base of the heat sink may become hot during running. Do not touch to avoid hurt.</li> </ul>								
	<ul style="list-style-type: none"> <li>✧ The electrical parts and components inside the inverter are electrostatic. Take measurements to avoid electrostatic discharge during relevant operation.</li> </ul>								

### 1.4.1 Delivery and installation

	<ul style="list-style-type: none"> <li>✧ Please install the inverter on fire-retardant material and keep the inverter away from combustible materials.</li> <li>✧ Connect the braking optional parts (braking resistors, braking units or feedback units) according to the wiring diagram.</li> <li>✧ Do not operate on the inverter if there is any damage or components loss to the inverter.</li> <li>✧ Do not touch the inverter with wet items or body, otherwise electric shock may occur.</li> </ul>
---	---

#### Note:

- ✧ Select appropriate moving and installing tools to ensure a safe and normal running of the inverter and avoid physical injury or death. For physical safety, the erector should take some mechanical protective measurements, such as wearing exposure shoes and working uniforms.
- ✧ Ensure to avoid physical shock or vibration during delivery and installation.
- ✧ Do not carry the inverter by its cover. The cover may fall off.
- ✧ Install away from children and other public places.
- ✧ The inverter cannot meet the requirements of low voltage protection in IEC61800-5-1 if the sea level of installation site is above 2000m.
- ✧ Please use the inverter on appropriate condition (See chapter **Installation Environment**).
- ✧ Don't allow screws, cables and other conductive items to fall inside the inverter.

- ✧ The leakage current of the inverter may be above 3.5mA during operation. Ground with proper techniques and ensure the grounding resistor is less than 10Ω. The conductivity of PE grounding conductor is the same as that of the phase conductor (with the same cross sectional area).
- ✧ R, S and T are the input terminals of the power supply, while U, V and W are the motor terminals. Please connect the input power cables and motor cables with proper techniques; otherwise the damage to the inverter may occur.

#### 1.4.2 Commission and running

	<ul style="list-style-type: none"> <li>✧ Disconnect all power supplies applied to the inverter before the terminal wiring and wait for at least the designated time after disconnecting the power supply.</li> <li>✧ High voltage is present inside the inverter during running. Do not carry out any operation except for the keypad setting.</li> <li>✧ The inverter may start up by itself when P01.21=1. Do not get close to the inverter and motor.</li> <li>✧ The inverter can not be used as “Emergency-stop device”.</li> <li>✧ The inverter can not be used to break the motor suddenly. A mechanical braking device should be provided.</li> </ul>
---	--

#### Note:

- ✧ Do not switch on or off the input power supply of the inverter frequently.
- ✧ For inverters that have been stored for a long time, check and fix the capacitance and try to run it again before utilization (see **Maintenance and Hardware Fault Diagnose**).
- ✧ Cover the front board before running, otherwise electric shock may occur.

#### 1.4.3 Maintenance and replacement of components

	<ul style="list-style-type: none"> <li>✧ Only qualified electricians are allowed to perform the maintenance, inspection, and components replacement of the inverter.</li> <li>✧ Disconnect all power supplies to the inverter before the terminal wiring. Wait for at least the time designated on the inverter after disconnection.</li> <li>✧ Take measures to avoid screws, cables and other conductive matters to fall into the inverter during maintenance and component replacement.</li> </ul>
--	---

#### Note:

- ✧ Please select proper torque to tighten screws.
- ✧ Keep the inverter, parts and components away from combustible materials during maintenance and component replacement.
- ✧ Do not carry out any isolation and pressure test on the inverter and do not measure the control circuit of the inverter by megameter.
- ✧ Carry out a sound anti-electrostatic protection to the inverter and its internal components during maintenance and component replacement.

#### 1.4.4 What to do after scrapping



✧ There are heavy metals in the inverter. Deal with it as industrial effluent.

KEILRIEMEN.AT

## 2 Quick Start-up

### 2.1 What this chapter contains

This chapter mainly describes the basic guidelines during the installation and commissioning procedures on the inverter, which you may follow to install and commission the inverter quickly.

### 2.2 Unpacking inspection

Check as follows after receiving products:

1. Check that there are no damage and humidification to the package. If not, please contact with local agents or MORGENSEN offices.
2. Check the information on the type designation label on the outside of the package to verify that the drive is of the correct type. If not, please contact with local dealers or MORGENSEN offices.
3. Check that there are no signs of water in the package and no signs of damage or breach to the inverter. If not, please contact with local dealers or MORGENSEN offices.
4. Check the information on the type designation label on the outside of the package to verify that the name plate is of the correct type. If not, please contact with local dealers or MORGENSEN offices.
5. Check to ensure the accessories (including user's manual, control keypad and extension card) inside the device is complete. If not, please contact with local dealers or MORGENSEN offices.

### 2.3 Application confirmation

Check the machine before beginning to use the inverter:

1. Check the load type to verify that there is no overload of the inverter during work and check that whether the drive needs to modify the power degree.
2. Check that the actual current of the motor is less than the rated current of the inverter.
3. Check that the control accuracy of the load is the same of the inverter.
4. Check that the incoming supply voltage is correspondent to the rated voltage of the inverter.

### 2.4 Environment

Check as follows before the actual installation and usage:

1. Check that the ambient temperature of the inverter is below 40℃. If exceeds, derate 3% for every additional 1℃. Additionally, the inverter can not be used if the ambient temperature is above 50℃. <b>Note:</b> for the cabinet inverter, the ambient temperature means the air temperature inside the cabinet.
2. Check that the ambient temperature of the inverter in actual usage is above -10℃. If not, add heating facilities.

<b>Note:</b> for the cabinet inverter, the ambient temperature means the air temperature inside the cabinet.
3. Check that the altitude of the actual usage site is below 1000m. If exceeds, derate 1% for every additional 100m.
4. Check that the humidity of the actual usage site is below 90% and condensation is not allowed. If not, add additional protection inverters.
5. Check that the actual usage site is away from direct sunlight and foreign objects can not enter the inverter. If not, add additional protective measures.
6. Check that there is no conductive dust or flammable gas in the actual usage site. If not, add additional protection to inverters.

## 2.5 Installation confirmation

Check as followings after the installation:

1. Check that the input and output cables meet the need of actual load.
2. Check that the accessories of the inverter are correctly and properly installed. The installation cables should meet the needs of every component (including reactors, input filters, output reactors, output filters, DC reactors, braking units and braking resistors).
3. Check that the inverter is installed on non-flammable materials and the calorific accessories (reactors and braking resistors) are away from flammable materials.
4. Check that all control cables and power cables are run separately and the routation complies with EMC requirement.
5. Check that all grounding systems are properly grounded according to the requirements of the inverter.
6. Check that the free space during installation is sufficient according to the instructions in user's manual.
7. Check that the installation conforms to the instructions in user's manual. The drive must be installed in an upright position.
8. Check that the external connection terminals are tightly fastened and the torque is appropriate.
9. Check that there are no screws, cables and other conductive items left in the inverter. If not, get them out.

## 2.6 Basic commission

Complete the basic commissioning as followings before actual utilization:

1. Select the motor type, set correct motor parameters and select control mode of the inverter according to the actual motor parameters.
2. Autotune. If possible, de-coupled from the motor load to start dynamic autotune. Or if not, static autotune is available.
3. Adjust the ACC/DEC time according to the actual running of the load.
4. Commission the device via jogging and check that the rotation direction is as required. If not, change the rotation direction by changing the wiring of motor.
5. Set all control parameters and then operate.

## 3 Product Overview

### 3.1 What this chapter contains

The chapter briefly describes the operation principle, product characteristics, layout, name plate and type designation information.

### 3.2 Basic principles

MSI200A series inverters are wall, flange and mountable devices for controlling asynchronous AC inductance motors.

The diagram below shows the main circuit diagram of the inverter. The rectifier converts three-phase AC voltage to DC voltage. The capacitor bank of the intermediate circuit stabilizes the DC voltage. The converter transforms the DC voltage back to AC voltage for the AC motor. The brake pipe connects the external braking resistor to the intermediate DC circuit to consume the feedback energy when the voltage in the circuit exceeds its maximum limit.

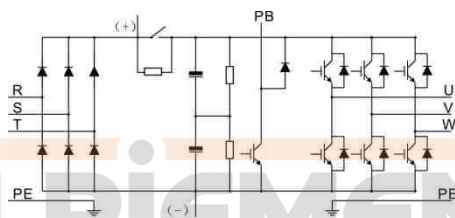

Diagram 3-1 The main circuit diagram ( $\leq 30\text{kW}$ )

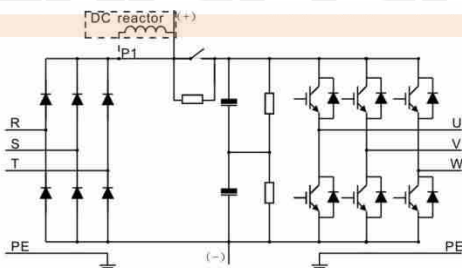

Diagram 3-2 The main circuit diagram ( $\geq 37\text{kW}$ )

#### Note:

1. The inverter above **37kW** (including **37kW**) supports external DC reactor which is an optional part. Before connecting, it is necessary to remove the copper row between **P1** and **(+)**.
2. The inverters ( $\leq 30\text{kW}$ ) have standard embedded braking units and the braking resistor is optional.
3. The inverters ( $\geq 37\text{kW}$ ) can be installed with optional braking units and the braking unit and resistor are optional.

### 3.3 Product specification

Function		Specification
Input	Input voltage (V)	AC 3PH 220V(-15%)~240V(+10%) AC 3PH 380V(-15%)~440V(+10%) AC 3PH 520V(-15%)~690V(+10%)
	Input current (A)	Refer to <i>the rated value</i>
	Input frequency (Hz)	50Hz or 60Hz Allowed range: 47~63Hz
Output	Output voltage (V)	0~Input voltage
	Output current (A)	Refer to <i>the rated value</i>
	Output power (kW)	Refer to <i>the rated value</i>
	Output frequency (Hz)	0~400Hz
Technical control feature	Control mode	SVPWM, SVC
	Motor type	Asynchronous motor
	Speed ratio	Asynchronous motor 1:100 (SVC)
	Speed control accuracy	±0.2% (sensorless vector control)
	Speed fluctuation	± 0.3%(sensorless vector control)
	Torque response	<20ms(sensorless vector control)
	Torque control accuracy	10%(sensorless vector control)
	Starting torque	Asynchronous motor: 0.5Hz/150% (SVC)
Overload capability	G type: 150% of rated current: 1 minute 180% of rated current: 10 seconds 200% of rated current: 1 second	
Running control feature	Frequency setting	Digital setting, analog setting, pulse frequency setting, multi-step speed running setting, simple PLC setting, PID setting, MODBUS communication setting. Shift between the set combination and set channel.
	Auto voltage adjustment	Keep a stable voltage automatically when the grid voltage transients
	Fault protection	Provide over 30 fault protection functions: overcurrent, overvoltage, undervoltage, overheating, phase loss and overload, etc.
	Speed tracking	Restart the rotating motor smoothly Note: This function is available for the inverters of 4kW and above 4kW.
Peripheral interface	Terminal analog input resolution	≤ 20mV
	Terminal switch input	≤ 2ms

Function		Specification
	resolution	
	Analog input	1 channels ( AI2) 0~10V/0~20mA and 1 channel (AI3) -10~10V
	Analog output	2 channels (AO1, AO2) 0~10V /0~20mA
	Digital input	8 channels common input, the Max. frequency: 1kHz, internal impedance: 3.3kΩ; 1 channel high speed input, the Max. frequency: 50kHz
	Digital output	1 channel high speed pulse output, the Max. frequency: 50kHz; 1 channel Y terminal open collector pole output
	Relay output	2 channels programmable relay output RO1A NO, RO1B NC, RO1C common terminal RO2A NO, RO2B NC, RO2C common terminal Contactor capability: 3A/AC250V,1A/DC30V
Others	Mountable method	Wall, flange and floor mountable
	Temperature of the running environment	-10~50℃, derate above 40℃
	Ingress protection	IP20
	Cooling	Air-cooling
	Braking unit	Built-in braking unit for inverters below 30kW (including 30kW) External braking unit for others
	EMC filter	Built-in C3 filter: meet the degree requirement of IEC61800-3 C3 External optional filter:meet the degree requirement of IEC61800-3 C2

### 3.4 Name plate



Fig 3-3 Name plate

Note: This is the example of the name plate for the standard products, and CE/TUV/IP20 will be marked according to the actual situations.

### 3.5 Type designation key

The type designation contains information on the inverter. The user can find the type



designation on the type designation label attached to the inverter or the simple name plate.

**MSI200A-011G/015P-4**  
A
B
C
D
E
F

Fig 3-4 Product type

Key	Instructions
A	MSI200A : abbreviation of MSI200A
B, D	3-digit code: output power. "R" means the decimal point; "011":11kW; "015":15kW
C, E	C   G:Constant torque load
	E   P:Variable torque load
F	Input voltage degree: 2: AC 3PH 220V(-15%)~240V(+10%) 4: AC 3PH 380V(-15%)~ 440V(+10%) 6: AC 3PH 520V(-15%)~690V(+10%)

### 3.6 Rated specifications

Model	Constant torque			Variable torque		
	Output power (kW)	Input current (A)	Output current (A)	Output power (kW)	Input current (A)	Output current (A)
MSI200A-0R7G-4	0.75	3.4	2.5			
MSI200A -1R5G-4	1.5	5.0	3.7			
MSI200A -2R2G-4	2.2	5.8	5			
MSI200A -004G/5R5P-4	4	13.5	9.5	5.5	19.5	14
MSI200A-5R5G/7R5P-4	5.5	19.5	14	7.5	25	18.5
MSI200A -7R5G/011P-4	7.5	25	18.5	11	32	25
MSI200A -011G/015P-4	11	32	25	15	40	32
MSI200A -015G/018P-4	15	40	32	18.5	47	38
MSI200A -018G/022P-4	18.5	47	38	22	56	45
MSI200A -022G/030P-4	22	56	45	30	70	60
MSI200A -030G/037P-4	30	70	60	37	80	75
MSI200A -037G/045P-4	37	80	75	45	94	92
MSI200A -045G/055P-4	45	94	92	55	128	115
MSI200A -055G/075P-4	55	128	115	75	160	150
MSI200A -075G/090P-4	75	160	150	90	190	180
MSI200A -090G/110P-4	90	190	180	110	225	215
MSI200A -110G/132P-4	110	225	215	132	265	260
MSI200A -132G/160P-4	132	265	260	160	310	305
MSI200A -160G/185P-4	160	310	305	185	345	340
MSI200A -185G/200P-4	185	345	340	200	385	380

Model	Constant torque			Variable torque		
	Output power (kW)	Input current (A)	Output current (A)	Output power (kW)	Input current (A)	Output current (A)
MSI200A -200G/220P-4	200	385	380	220	430	425
MSI200A -220G/250P-4	220	430	425	250	485	480
MSI200A -250G/280P-4	250	485	480	280	545	530
MSI200A -280G/315P-4	280	545	530	315	610	600
MSI200A -315G/350P-4	315	610	600	350	625	650
MSI200A -350G/400P-4	350	625	650	400	715	720
MSI200A -400G-4	400	715	720			
MSI200A -500G-4	500	890	860			

**Note:**

1. The input current of 1.5~315kW inverters is measured when the input voltage is 380V and no DC reactor and input/output reactor.
2. The input current of 350~500kW inverters is measured when the input voltage is 380V and the circuit is with input reactor.
3. The rated output current is defined as the output current when the output voltage is 380V.
4. In the allowable voltage range, the output power and current can not exceed the rated output power and current in any situation.

### 3.7 Structure diagram

Below is the layout figure of the inverter (take the inverter of 30kW as the example).

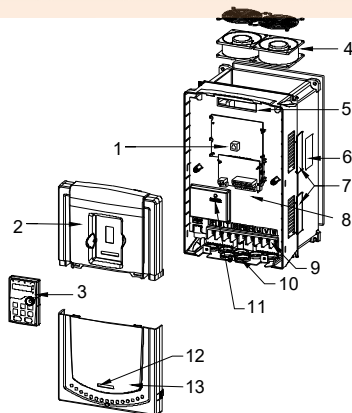



Fig 3-5 Product structure diagram

Serial No.	Name	Illustration
1	Keypad port	Connect the keypad
2	Upper cover	Protect the internal parts and components
3	Keypad	See <b>Keypad Operation Procedure</b> for detailed information
4	Cooling fan	See <b>Maintenance and Hardware Fault Diagnose</b> for detailed information
5	Wires port	Connect to the control board and the drive board
6	Name plate	See <b>Product Overview</b> for detailed information
7	Side cover	Optional part. The side cover will increase the protective degree of the inverter. The internal temperature of the inverter will increase, too, so it is necessary to derate the inverter at the same time
8	Control terminals	See <b>Electric Installation</b> for detailed information
9	Main circuit terminals	See <b>Electric Installation</b> for detailed information
10	Main circuit cable entry	Fix the main circuit cable
11	POWER light	Power indicator
12	Simple name plate	See <b>Product Overview</b> for detailed information
13	Lower cover	Protect the internal parts and components

## 4 Installation Guidelines

### 4.1 What this chapter contains

The chapter describes the mechanical installation and electric installation.

	<ul style="list-style-type: none"> <li>◇ Only qualified electricians are allowed to carry out what described in this chapter. Please operate as the instructions in <b>Safety Precautions</b>. Ignoring these may cause physical injury or death or damage to the devices.</li> <li>◇ Ensure the power supply of the inverter is disconnected during the operation. Wait for at least the time designated until the POWER indicator is off after the disconnection if the power supply is applied. It is recommended to use the multimeter to monitor that the DC bus voltage of the drive is under 36V.</li> <li>◇ The installation and design of the inverter should be complied with the requirement of the local laws and regulations in the installation site. If the installation infringes the requirement, our company will exempt from any responsibility. Additionally, if users do not comply with the suggestion, some damage beyond the assured maintenance range may occur.</li> </ul>
---	--

### 4.2 Mechanical installation

#### 4.2.1 Installation environment

The installation environment is important for a full performance and long-term stable functions of the inverter. Check the installation environment as followings:

Environment	Conditions
Installation site	Indoor
Environment temperature	<p>-10~+50°C</p> <p>If the ambient temperature of the inverter is above 40°C, derate 3% for every additional 1°C.</p> <p>It is not recommended to use the inverter if the ambient temperature is above 50°C.</p> <p>In order to improve the reliability of the device, do not use the inverter if the ambient temperature changes frequently.</p> <p>Please provide cooling fan or air conditioner to control the internal ambient temperature below the required one if the inverter is used in a close space such as in the control cabinet.</p> <p>When the temperature is too low, if the inverter needs to restart to run after a long stop, it is necessary to provide an external heating device to increase the internal temperature, otherwise damage to the devices may occur.</p>
Humidity	<p>RH≤90%</p> <p>No condensation is allowed.</p> <p>The maximum relative humidity should be equal to or less than</p>

Environment	Conditions
	60% in corrosive air.
Storage temperature	-30~+60℃
Running environment condition	The installation site of the inverter should: keep away from the electromagnetic radiation source; keep away from contaminative air, such as corrosive gas, oil mist and flammable gas; ensure foreign objects, such as metal power, dust, oil, water can not enter into the inverter(do not install the inverter on the flammable materials such as wood); keep away from direct sunlight, oil mist, steam and vibration environment.
Altitude	Below 1000m If the sea level is above 1000m, please derate 1% for every additional 100m.
Vibration	$\leq 5.8\text{m/s}^2(0.6\text{g})$
Installation direction	The inverter should be installed on an upright position to ensure sufficient cooling effect.

**Note:**

- ◆ MSI200A series inverters should be installed in a clean and ventilated environment according to enclosure classification.
- ◆ Cooling air must be clean, free from corrosive materials and electrically conductive dust.

**4.2.2 Installation direction**

The inverter may be installed on the wall or in a cabinet.

The inverter must be installed in an upright position. Check the installation site according to the requirements below. Refer to chapter **Dimension Drawings** in the appendix for frame details.

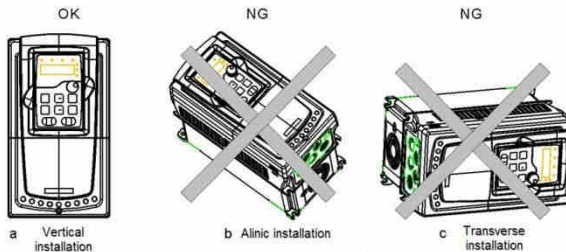

Fig 4-1 Installation direction of the inverter

### 4.2.3 Installation manner

The inverter can be installed in two different ways, depending on the frame size:

- a) Wall mounting (for the inverters  $\leq 315\text{kW}$ )
- b) Flange mounting (for the inverters  $\leq 200\text{kW}$ ). Some need optional flange installation board.
- c) Floor mounting ( $220\text{kW} \leq$  the inverters  $\leq 500\text{kW}$ ). Some need optional base.

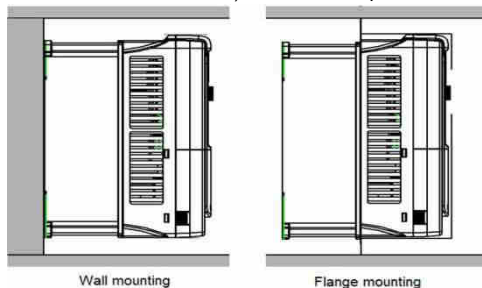

Fig 4-2 Installation manner

- (1) Mark the hole location. The location of the holes is shown in the dimension drawings in the appendix.
- (2) Fix the screws or bolts to the marked locations.
- (3) Position the drive onto the wall.
- (4) Tighten the screws in the wall securely.

**Note:**

1. The flange installation bracket is needed in the flange installation of 1.5~30kW inverters, which the flange installation of 37~200kW inverters does not need the installation bracket.
2. 220~315kW inverters need optional base in the floor installation.

### 4.2.4 Multiple installations

#### Parallel installation

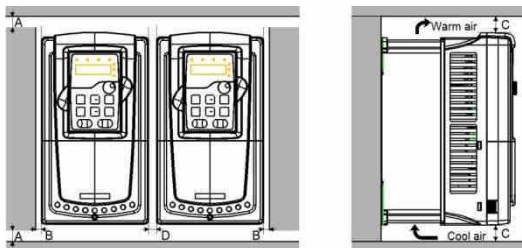

Fig 4-3 Parallel installation

**Note:**

- ◆ Before installing the different sizes inverters, please align their top position for the convenience of later maintenance.
- ◆ The minimum space of B, D and C is 100mm.

#### 4.2.5 Vertical installation

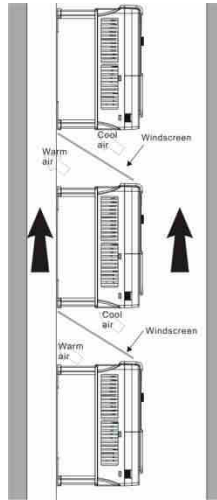

Fig 4-4 Vertical installation

**Note:** Windscreen should be added in vertical installation for avoiding mutual impact and insufficient cooling.

#### 4.2.6 Tilt installation

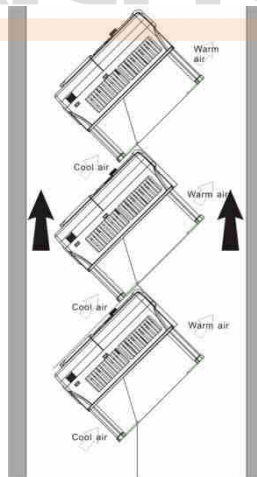

Fig 4-5 Tilt installation

**Note:** Ensure the separation of the wind input and output channels in tilt installation for avoiding mutual impact.

KILRIEMEN.AT

## 4.3 Standard wiring

### 4.3.1 Wiring diagram of main circuit

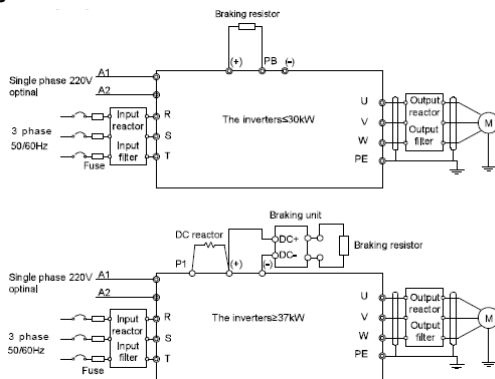

Fig 4-6 Wiring diagram of main circuit

**Note:**

- ◆ The fuse, DC reactor, braking unit, braking resistor, input reactor, input filter, output reactor, output filter are optional parts. Please refer to **Peripheral Optional Parts** for detailed information.
- ◆ **A1** and **A2** are optional parts.
- ◆ **P1** and **(+)** are short circuited in factory, if need to connect with the DC reactor, please remove the contact tag between **P1** and **(+)**.

### 4.3.2 Terminals figure of main circuit

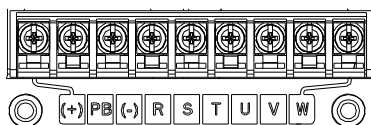

Fig 4-7 0.75~5.5 kW terminals of main circuit

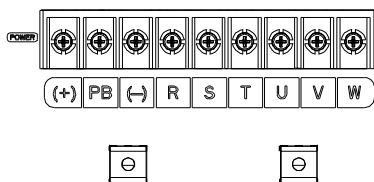

Fig 4-8 7.5~15kW terminals of main circuit



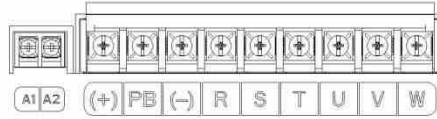

Fig 4-9 18.5kW terminals of main circuit

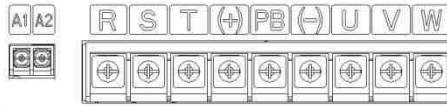

Fig 4-10 22~30kW terminals of main circuit

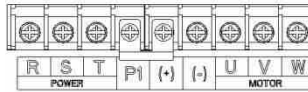

Fig 4-11 37~55 kW terminals of main circuit

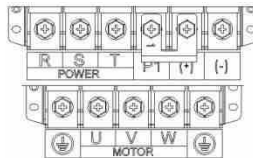

Fig 4-12 75~110kW terminals of main circuit

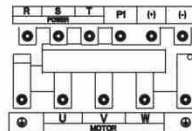

Fig 4-13 132~200kW terminals of main circuit

**KEILRIEMEN.AT**

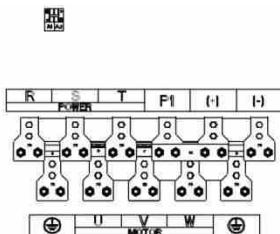

Fig 4-14 220~315kW terminals of main circuit

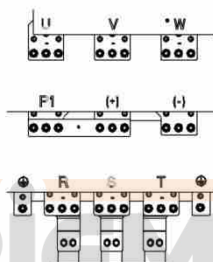

Fig 4-15 350~500kW terminals of main circuit

Terminal	Terminal name		Function
	≤30kW	≥37kW	
R, S, T	Power input of the main circuit		3-phase AC input terminals which are generally connected with the power supply.
U, V, W	The inverter output		3-phase AC output terminals which are generally connected with the motor.
P1	This terminal is inexistent	DC reactor terminal 1	P1 and (+) are connected with the terminals of DC reactor.
(+)	Braking resistor terminal 1	DC reactor terminal 2, braking unit terminal 1	
(-)	/	Braking unit terminal 2	(+) and (-) are connected with the terminals of braking unit.
PB	Braking resistor terminal 2	This terminal is inexistent.	PB and (+) are connected with the terminals of braking resistor.
PE	380V:the grounding resistor is less than 10Ohm		Protective grounding terminals, every machine is provided 2 PE terminals as the standard configuration. These terminals should be grounded with proper techniques.
A1 and A2	Control power supply terminal		Optional parts (external 220V control

Terminal	Terminal name		Function
	≤30kW	≥37kW	
			power supply)

**Note:**

- ◆ Do not use an asymmetrically constructed motor cable. If there is a symmetrically constructed grounding conductor in the motor cable in addition to the conductive shield, connect the grounding conductor to the grounding terminal at the inverter and motor ends.
- ◆ Braking resistor, braking unit and DC reactor are optional parts.
- ◆ Route the motor cable, input power cable and control cables separately.
- ◆ If the terminal is not appeared, the machine does not provide the terminal as the external terminal.

**4.3.3 Wiring of terminals in main circuit**

1. Fasten the grounding conductor of the input power cable with the grounding terminal of the inverter (**PE**) by **360** degree grounding technique. Connect the phase conductors to **R**, **S** and **T** terminals and fasten.
2. Strip the motor cable and connect the shield to the grounding terminal of the inverter by **360** degree grounding technique. Connect the phase conductors to **U**, **V** and **W** terminals and fasten.
3. Connect the optional brake resistor with a shielded cable to the designated position by the same procedures in the previous step.
4. Secure the cables outside the inverter mechanically.

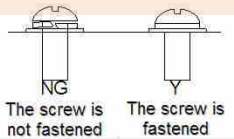

Fig 4-16 Correct installation of the screw

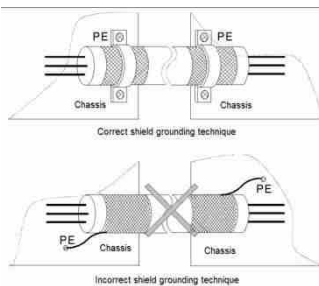

Fig 4-17 360 degree grounding technique

### 4.3.4 Wiring diagram of control circuit

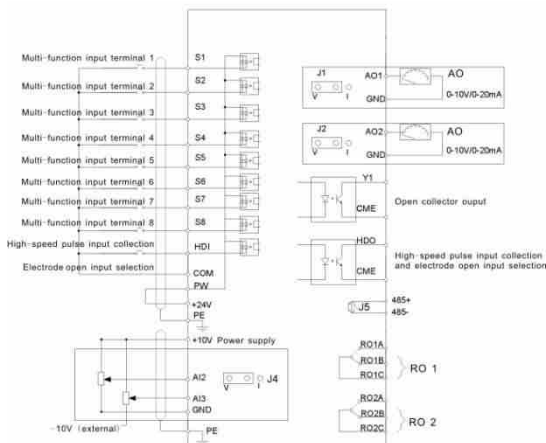

Fig 4-18 Wiring diagram of the control circuit

### 4.3.5 Terminals of control circuit

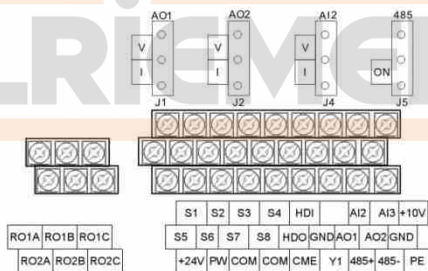

Fig 4-19 0.75~15kW Terminals of control circuit

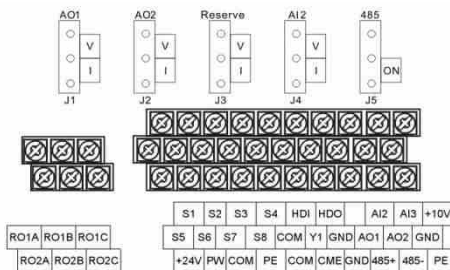

Fig 4-20 18.5~500kW Terminals of control circuit

Note: the spare terminal is reserved and not be used.

Terminal	Description
----------	-------------

name		
+10V	Local power supply +10V	
AI2	1. Input range: AI2 voltage and current can be chose: 0~10V/0~20mA; AI2 can be shifted by J4; AI3:-10V~+10V	
AI3	2. Input impedance: voltage input: 20kΩ; current input: 500Ω 3. Resolution: the minimum one is 5mV when 10V corresponds to 50Hz 4. Deviation ±1%, 25°C	
GND	+10V reference null potential	
AO1	1. Output range:0~10V or 0~20mA; AO1 can be shifted by J1; AO2 can be shifted by J2	
AO2	2. Deviation±1%,25°C	
RO1A	RO1 relay output, RO1A NO, RO1B NC, RO1C common terminal Contactor capability: 3A/AC250V,1A/DC30V	
RO1B		
RO1C		
RO2A	RO2 relay output, RO2A NO, RO2B NC, RO2C common terminal Contactor capability: 3A/AC250V,1A/DC30V	
RO2B		
RO2C		
PE	Grounding terminal	
PW	Provide the input switch working power supply from external to internal. Voltage range: 12~24V	
24V	The inverter provides the power supply for users with a maximum output current of 200mA	
COM	+24V common terminal	
S1	Switch input 1	1. Internal impedance:3.3kΩ 2. 12~30V voltage input is available 3. The terminal is the dual-direction input terminal supporting both NPN and PNP 4. Max input frequency:1kHz 5. All are programmable digital input terminal. User can set the terminal function through function codes.
S2	Switch input 2	
S3	Switch input 3	
S4	Switch input 4	
S5	Switch input 5	
S6	Switch input 6	
S7	Switch input 7	
S8	Switch input 8	
HDI	Except for S1~S8, this terminal can be used as high frequency input channel. Max. input frequency:50kHz	
HDO	1. Switch input:200mA/30V 2. Output frequency range:0~50kHz	
COM	+24V common terminal	
CME	Common terminal of HDO and Y1, short-connected with COM in factory	
Y1	1.Swtich capability:200mA/30V 2.Output frequency range:0~1kHz	
485+	485 communication interface and 485 differential signal interface	
485-	If it is the standard 485 communication interface, please use twisted pairs or shield cable.	

### 4.3.6 Input /Output signal connection figure

Please use U-shaped contact tag to set NPN mode or PNP mode and the internal or external power supply. The default setting is NPN internal mode.

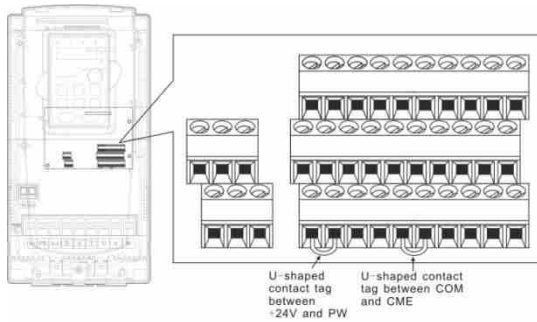

Fig 4-21 U-shaped contact tag

If the signal is from NPN transistor, please set the U-shaped contact tag between +24V and PW as below according to the used power supply.

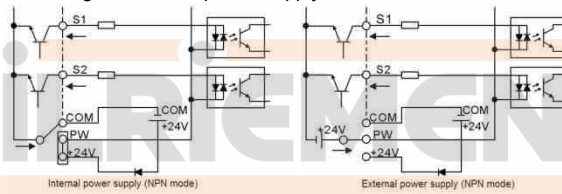

Fig 4-22 NPN modes

If the signal is from PNP transistor, please set the U-shaped contact tag as below according to the used power supply.

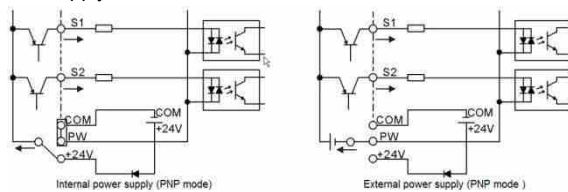

Fig 4-23 PNP modes

## 4.4 Layout protection

### 4.4.1 Protecting the inverter and input power cable in short-circuit situations

Protect the inverter and input power cable in short circuit situations and against thermal overload.

Arrange the protection according to the following guidelines.

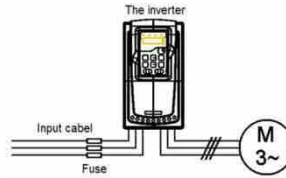

Fig 4-24 Fuse configuration

**Note:** Select the fuse as the manual indicated. The fuse will protect the input power cable from damage in short-circuit situations. It will protect the surrounding devices when the internal of the inverter is short circuited.

#### 4.4.2 Protecting the motor and motor cable in short-circuit situations

The inverter protects the motor and motor cable in a short-circuit situation when the motor cable is dimensioned according to the rated current of the inverter. No additional protection devices are needed.

	<p>◇ <b>If the inverter is connected to multiple motors, a separate thermal overload switch or a circuit breaker must be used for protecting each cable and motor. These devices may require a separate fuse to cut off the short-circuit current.</b></p>
--	--

#### 4.4.3 Protecting the motor against thermal overload

According to regulations, the motor must be protected against thermal overload and the current must be switched off when overload is detected. The inverter includes a motor thermal protection function that protects the motor and closes the output to switch off the current when necessary.

#### 4.4.4 Implementing a bypass connection

It is necessary to set power frequency and variable frequency conversion circuits for the assurance of continuous normal work of the inverter if faults occur in some significant situations.

In some special situations, for example, if it is only used in soft start, the inverter can be converted into power frequency running after starting and some corresponding bypass should be added.

	<p>◇ <b>Never connect the supply power to the inverter output terminals U, V and W. Power line voltage applied to the output can result in permanent damage to the inverter.</b></p>
--	--

If frequent shifting is required, employ mechanically connected switches or contactors to ensure that the motor terminals are not connected to the AC power line and inverter output terminals simultaneously.

## 5 Keypad Operation Procedure

### 5.1 What this chapter contains

This chapter contains following operation:

- Buttons, indicating lights and the screen as well as the methods to inspect, modify and set function codes by keypad
- Start-up

### 5.2 Keypad

The keypad is used to control MSI200A series inverters, read the state data and adjust parameters.







Fig 5-1 Keypad

**Note:** The keypad of 0.75~15kW as show in Fig 5-1 A, and 18.5~500kW as show in Fig 5-1 B; The inverters of 0.75~30kW can choose optional LED keypad and 0.75~500kW can choose optional LCD keypad . The LCD keypad supports several languages, parameters copy, high-definition display and its installation dimension is compatible with the LED.

Use screw or installation bracket to fix the external keypad. The inverters of 0.75~30kW have standard bracket, while the inverters of 37~500kW have optimal bracket.

No.	Name	Description	
1	State LED	RUN/TUNE	LED off means that the inverter is in the stopping state; LED blinking means the inverter is in the parameter autotune state; LED on means the inverter is in the running state.
		FWD/REV	FED/REV LED LED off means the inverter is in the



No.	Name	Description	
			forward rotation state; LED on means the inverter is in the reverse rotation state
		LOCAL/REMOT	LED for keypad operation, terminals operation and remote communication control LED off means that the inverter is in the keypad operation state; LED blinking means the inverter is in the terminals operation state; LED on means the inverter is in the remote communication control state.
		TRIP	LED for faults LED on when the inverter is in the fault state; LED off in normal state; LED blinking means the inverter is in the pre-alarm state.
2	Unit LED	Mean the unit displayed currently	
		Hz	Frequency unit
		RPM	Rotating speed unit
		A	Current unit
		%	Percentage
	V	Voltage unit	
3	Code displaying zone	5-figure LED display displays various monitoring data and alarm code such as set frequency and output frequency.	
4	Digital potentiometer	Tuning frequency. Please refer to P08.42.	
5	Buttons		Programming key Enter or escape from the first level menu and remove the parameter quickly
			Entry key Enter the menu step-by-step Confirm parameters
			UP key Increase data or function code progressively
			DOWN key Decrease data or function code progressively
			Right-shift key Move right to select the displaying parameter circularly in stopping and running mode.

No.	Name	Description	
			Select the parameter modifying digit during the parameter modification
		Run key	This key is used to operate on the inverter in key operation mode
		Stop/ Reset key	This key is used to stop in running state and it is limited by function code P07.04 This key is used to reset all control modes in the fault alarm state
		Quick key	The function of this key is confirmed by function code P07.02.

### 5.3 Keypad displaying

The keypad displaying state of MSI200A series inverters is divided into stopping state parameter, running state parameter, function code parameter editing state and fault alarm state and so on.

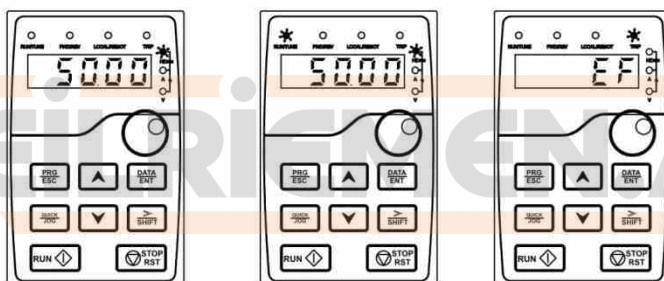

Fig 5-2 Displayed state

### 5.4 Keypad operation

Operate the inverter via operation panel. See the detailed structure description of function codes in the brief diagram of function codes.

#### 5.4.1 How to modify the function codes of the inverter

The inverter has three levels menu, which are:

1. Group number of function code (first-level menu)
2. Tab of function code (second-level menu)
3. Set value of function code (third-level menu)

Remarks: Press both the **PRG/ESC** and the **DATA/ENT** can return to the second-level menu from the third-level menu. The difference is: pressing **DATA/ENT** will save the set parameters into the control panel, and then return to the second-level menu with shifting to the next function code automatically; while pressing **PRG/ESC** will directly return to the second-level menu without saving the parameters, and keep staying at the current function code.

Under the third-level menu, if the parameter has no flickering bit, it means the function code

cannot be modified. The possible reasons could be:

- 1) This function code is not modifiable parameter, such as actual detected parameter, operation records and so on;
- 2) This function code is not modifiable in running state, but modifiable in stop state.

Example: Set function code P00.01 from 0 to 1.

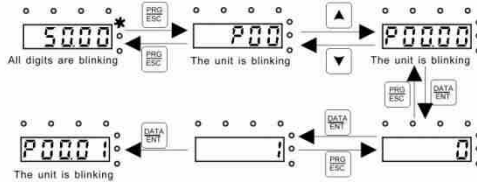

Fig 5-3 Sketch map of modifying parameters

#### 5.4.2 How to set the password of the inverter

MSI200A series inverters provide password protection function to users. Set P7.00 to gain the password and the password protection becomes valid instantly after quitting from the function code editing state. Press **PRG/ESC** again to the function code editing state, "0.0.0.0.0" will be displayed. Unless using the correct password, the operators cannot enter it.

Set P7.00 to 0 to cancel password protection function.

The password protection becomes effective instantly after retreating from the function code editing state. Press **PRG/ESC** again to the function code editing state, "0.0.0.0.0" will be displayed. Unless using the correct password, the operators cannot enter it.

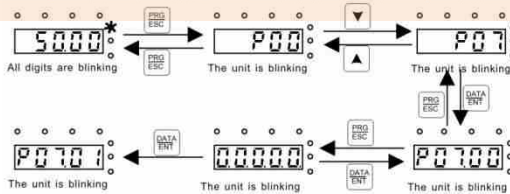

Fig 5-4 Sketch map of password setting

#### 5.4.3 How to watch the inverter state through function codes

MSI200A series inverters provide group P17 as the state inspection group. Users can enter into P17 directly to watch the state.

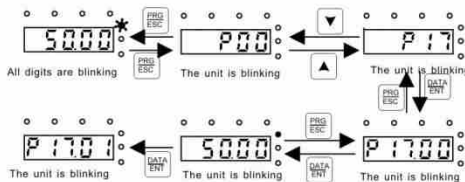

Fig 5-5 Sketch map of state watching

## 6 Function Parameters

### 6.1 What this chapter contains

This chapter lists and describes the function parameters.

### 6.2 MSI200A general series function parameters

The function parameters of MSI200A series inverters have been divided into 30 groups (P00~P29) according to the function, of which P18~P28 are reserved. Each function group contains certain function codes applying 3-level menus. For example, "P08.08" means the eighth function code in the P8 group function, P29 group is factory reserved, and users are forbidden to access these parameters.

For the convenience of function codes setting, the function group number corresponds to the first level menu, the function code corresponds to the second level menu and the function code corresponds to the third level menu.

1. Below is the instruction of the function lists:

**The first line** "Function code": codes of function parameter group and parameters;

**The second line** "Name": full name of function parameters;

**The third line** "Detailed illustration of parameters": detailed illustration of the function parameters;

**The fourth line** "Default value": the original factory set value of the function parameter;

**The fifth line** "Modify": the modifying character of function codes (the parameters can be modified or not and the modifying conditions), below is the instruction:

“○”: means the set value of the parameter can be modified on stop and running state;

“◎”: means the set value of the parameter can not be modified on the running state;

“●”: means the value of the parameter is the real detection value which can not be modified.

(The inverter has limited the automatic inspection of the modifying character of the parameters to help users avoid mismodifying).

2. "Parameter radix" is decimal (DEC), if the parameter is expressed by hex, then the parameter is separated from each other when editing. The setting range of certain bits are 0~F (hex).

3. "The default value" means the function parameter will restore to the default value during default parameters restoring. But the detected parameter or recorded value won't be restored.

4. For a better parameter protection, the inverter provides password protection to the parameters. After setting the password (set P07.00 to any non-zero number), the system will come into the state of password verification firstly after the user press **PRG/ESC** to come into the function code editing state. And then "0.0.0.0.0." will be displayed. Unless the user input right password, they cannot enter into the system. For the factory setting parameter zone, it needs correct factory password (remind that the users can not modify the factory parameters by themselves, otherwise, if the parameter setting is incorrect, damage to the inverter may occur). If the password protection is unlocked, the user can modify the

password freely and the inverter will work as the last setting one. When P07.00 is set to 0, the password can be canceled. If P07.00 is not 0 during powering on, then the parameter is protected by the password. When modify the parameters by serial communication, the function of the password follows the above rules, too.

Function code	Name	Detailed instruction of parameters	Default value	Modify
<b>P00 Group Basic function group</b>				
P00.00	Speed control mode	<p>1: Sensorless vector control mode 1 (applying to AM) No need to install encoders. It is suitable in cases with high speed control accuracy for accurate speed and torque control at all power ratings.</p> <p>2:SVPWM control No need to install encoders. It can improve the control accuracy with the advantages of stable operation, valid low-frequency torque boost and current vibration suppression and the functions of slip compensation and voltage adjustment.</p> <p><b>Note:</b> AM-Asynchronous motor</p>	2	☉
P00.01	Run command channel	<p>Select the run command channel of the inverter. The control command of the inverter includes: start-up, stop, forward, reverse, jogging and fault reset.</p> <p>0:Keypad running command channel("LOCAL/REMOT" light off) Carry out the command control by <b>RUN</b>, <b>STOP/RST</b> on the keypad. Set the multi-function key <b>QUICK/JOG</b> as <b>FWD/REV</b> shifting function (P07.02=3) to change the running direction; press <b>RUN</b> and <b>STOP/RST</b> simultaneously in running state to make the inverter coast to stop.</p> <p>1:Terminal running command channel ("LOCAL/REMOT" flickering) Carry out the running command control by the forward rotation, reverse rotation and forward jogging and reverse jogging of the multi-function terminals</p> <p>2:Communication running command channel ("LOCAL/REMOT" on); The running command is controlled by the upper monitor via communication.</p>	0	○
P00.02	Communication selection	<p>0: MODBUS communication 1~3: Reserved</p>	0	○

Function code	Name	Detailed instruction of parameters	Default value	Modify
P00.03	Max. output frequency	This parameter is used to set the Maximum output frequency of the inverter. Users should pay attention to this parameter because it is the foundation of the frequency setting and the speed of acceleration and deceleration. Setting range: P00.04~400.00Hz	50.00 Hz	⊙
P00.04	Upper limit of the running frequency	The upper limit of the running frequency is the upper limit of the output frequency of the inverter which is lower than or equal to the maximum frequency. Setting range:P00.05~P00.03 (Max. output frequency)	50.00 Hz	⊙
P00.05	Lower limit of the running frequency	The lower limit of the running frequency is that of the output frequency of the inverter. The inverter runs at the lower limit frequency if the set frequency is lower than the lower limit one. <b>Note:</b> Max. output frequency $\geq$ Upper limit frequency $\geq$ Lower limit frequency Setting range:0.00Hz~P00.04 (Upper limit of the running frequency)	0.00Hz	⊙
P00.06	A frequency command	0:Keypad data setting Modify the value of P00.10 (set the frequency by keypad) to modify the frequency by the keypad.	0	○
P00.07	B frequency command	1:Analog AI1 setting(The inverter( $\leq 15kW$ ) can be set by the analog potentiometer on the keypad and AI1 setting is not available for the device which is 18.5kW or higer than 18.5kW) 2:Analog AI2 setting 3:Analog AI3 setting Set the frequency by analog input terminals. MSI200A series inverters provide 3 channels analog input terminals as the standard configuration, of which AI1/AI2 are the voltage/current option (0~10V/0~20mA) which can be shifted by jumpers; while AI3 is voltage input (-10V~+10V). <b>Note:</b> when analog AI1/AI2 select 0~20mA input, the corresponding voltage of 20mA is 10V. 100.0% of the analog input setting corresponds to the maximum frequency (function code P00.03) in forward direction and -100.0%	2	○

Function code	Name	Detailed instruction of parameters	Default value	Modify
		<p>corresponds to the maximum frequency in reverse direction (function code P00.03)</p> <p>4:High-speed pulse HDI setting</p> <p>The frequency is set by high-speed pulse terminals. MSI200A series inverters provide 1 channel high speed pulse input as the standard configuration. The pulse frequency range is 0.00~50.00kHz.</p> <p>100.0% of the high speed pulse input setting corresponds to the maximum frequency in forward direction (P00.03) and -100.0% corresponds to the maximum frequency in reverse direction (P00.03).</p> <p><b>Note:</b> The pulse setting can only be input by multi-function terminals HDI. Set P05.00 (HDI input selection) to high speed pulse input, and set P05.49 (HDI high speed pulse input function selection) to frequency setting input.</p> <p>5:Simple PLC program setting</p> <p>The inverter runs at simple PLC program mode when P00.06=5 or P00.07=5. Set P10 (simple PLC and multi-step speed control) to select the running frequency, running direction, ACC/DEC time and the keeping time of corresponding step. See the function description of P10 for detailed information.</p> <p>6: Multi-step speed running setting</p> <p>The inverter runs at multi-step speed mode when P00.06=6 or P00.07=6. Set P05 to select the current running step, and set P10 to select the current running frequency.</p> <p>The multi-step speed has the priority when P00.06 or P00.07 does not equal to 6, but the setting step can only be the 1~15 step. The setting step is 0~15 if P00.06 or P00.07 equals to 6.</p> <p>7: PID control setting</p> <p>The running mode of the inverter is process PID control when P00.06=7 or P00.07=7. It is necessary to set P09. The running frequency of the inverter is the value after PID effect. See P09 for the detailed information of the preset source,</p>		

Function code	Name	Detailed instruction of parameters	Default value	Modify
		<p>preset value, and feedback source of PID.</p> <p>8:MODBUS communication setting The frequency is set by MODBUS communication. See P14 for detailed information.</p> <p>9~11: Reserved</p> <p><b>Note:</b> A frequency and B frequency can not set as the same frequency reference mode.</p>		
P00.08	B frequency command reference	<p>0:Maximum output frequency, 100% of B frequency setting corresponds to the maximum output frequency</p> <p>1: A frequency command, 100% of B frequency setting corresponds to the maximum output frequency. Select this setting if it needs to adjust on the base of A frequency command.</p>	0	<input type="radio"/>
P00.09	Combination of the setting source	<p>0: A, the current frequency setting is A frequency command</p> <p>1: B, the current frequency setting is B frequency command</p> <p>2: A+B, the current frequency setting is A frequency command + B frequency command</p> <p>3: A-B, the current frequency setting is A frequency command - B frequency command</p> <p>4: Max (A, B): the bigger one between A frequency command and B frequency is the set frequency.</p> <p>5: Min (A, B): The lower one between A frequency command and B frequency is the set frequency.</p> <p><b>Note:</b>The combination manner can be shifted by P05(terminal function)</p>	0	<input type="radio"/>
P00.10	Keypad set frequency	<p>When A and B frequency commands are selected as "keypad setting", this parameter will be the initial value of inverter reference frequency</p> <p>Setting range:0.00 Hz~P00.03 (the Max. frequency)</p>	50.00 Hz	<input type="radio"/>
P00.11	ACC time 1	<p>ACC time means the time needed if the inverter speeds up from 0Hz to the Max. One (P00.03).</p> <p>DEC time means the time needed if the inverter speeds down from the Max. Output frequency to 0Hz (P00.03).</p>	Depend on model	<input type="radio"/>



Function code	Name	Detailed instruction of parameters	Default value	Modify						
P00.12	DEC time 1	MSI200A series inverters define four groups of ACC/DEC time which can be selected by P05. The factory default ACC/DEC time of the inverter is the first group. Setting range of P00.11 and P00.12:0.0~3600.0s	Depend on model	<input type="radio"/>						
P00.13	Running direction	0: Runs at the default direction, the inverter runs in the forward direction. <b>FWD/REV</b> indicator is off. 1: Runs at the opposite direction, the inverter runs in the reverse direction. <b>FWD/REV</b> indicator is on. Modify the function code to shift the rotation direction of the motor. This effect equals to the shifting the rotation direction by adjusting either two of the motor lines (U, V and W). In keypad control, the motor rotation direction can be changed by <b>QUICK/JOG</b> on the keypad. Refer to parameter P07.02. <b>Note:</b> When the function parameter comes back to the default value, the motor's running direction will come back to the factory default state, too. In some cases it should be used with caution after commissioning if the change of rotation direction is disabled. 2: Forbid to run in reverse direction: It can be used in some special cases if the reverse running is disabled.	0	<input type="radio"/>						
P00.14	Carrier frequency setting	<p>The relationship table of the motor type and carrier frequency:</p> <table border="1"> <thead> <tr> <th>Model</th> <th>Factory setting of carrier frequency</th> </tr> </thead> <tbody> <tr> <td>1.5~11kW</td> <td>8kHz</td> </tr> <tr> <td>15~55kW</td> <td>4kHz</td> </tr> </tbody> </table>	Model	Factory setting of carrier frequency	1.5~11kW	8kHz	15~55kW	4kHz	Depend on model	<input type="radio"/>
Model	Factory setting of carrier frequency									
1.5~11kW	8kHz									
15~55kW	4kHz									

Function code	Name	Detailed instruction of parameters	Default value	Modify		
		<table border="1" style="margin-left: 20px;"> <tr> <td style="width: 150px;">Above 75kW</td> <td>2kHz</td> </tr> </table> <p>The advantage of high carrier frequency: ideal current waveform, little current harmonic wave and motor noise.</p> <p>The disadvantage of high carrier frequency: increasing the switch loss, increasing inverter temperature and the impact to the output capacity. The inverter needs to derate on high carrier frequency. At the same time, the leakage and electrical magnetic interference will increase. Applying low carrier frequency is contrary to the above, too low carrier frequency will cause unstable running, torque decreasing and surge. The manufacturer has set a reasonable carrier frequency when the inverter is in factory. In general, users do not need to change the parameter.</p> <p>When the frequency used exceeds the default carrier frequency, the inverter needs to derate 20% for each additional 1k carrier frequency. Setting range:1.0~15.0kHz</p>	Above 75kW	2kHz		
Above 75kW	2kHz					
P00.15	Motor parameter autotuning	<p>0:No operation</p> <p>1:Rotation autotuning Comprehensive motor parameter autotune It is recommended to use rotation autotuning when high control accuracy is needed.</p> <p>2:Static autotuning 1 It is suitable in the cases when the motor can not de-couple from the load.</p> <p>3:Static autotuning 2 It is suitable in the cases when the motor can not de-couple form the load. But only for parts of parameters.</p>	0	<input checked="" type="radio"/>		
P00.16	AVR function selection	<p>0:Invalid</p> <p>1:Valid during the whole procedure The auto-adjusting function of the inverter can cancel the impact on the output voltage of the inverter because of the bus voltage fluctuation.</p>	1	<input type="radio"/>		
P00.17	Inverter type	<p>0:G type, for the constant torque load of rated parameters</p> <p>1:P type; for the variable torque load of rated</p>	0	<input checked="" type="radio"/>		

Function code	Name	Detailed instruction of parameters	Default value	Modify
		parameters (fans and water pumps) MSI200A series inverters can use G/P type, the available motor power of G type is small one power file than that of P type.		
P00.18	Function restore parameter	0:No operation 1:Restore the default value 2:Clear fault records <b>Note:</b> The function code will restore to 0 after finishing the operation of the selected function code. Restoring to the default value will cancel the user password, please use this function with caution.	0	⊙
<b>P01 Group Start-up and stop control</b>				
P01.00	Start mode	0:Start-up directly:start from the starting frequency P01.01 1:Start-up after DC braking: start the motor from the starting frequency after DC braking (set the parameter P01.03 and P01.04). It is suitable in the cases where reverse rotation may occur to the low inertia load during starting. 2: Start-up after speed tracking: start the rotating motor smoothly after tracking the rotation speed and direction automatically. It is suitable in the cases where reverse rotation may occur to the big inertia load during starting. Note: This function is available for the inverters of 4kW and above.	0	⊙
P01.01	Starting frequency of direct start	Starting frequency of direct start-up means the original frequency during the inverter starting. See P01.02 for detailed information. Setting range: 0.00~50.00Hz	0.50Hz	⊙
P01.02	Retention time of the starting frequency	Set a proper starting frequency to increase the torque of the inverter during starting. During the retention time of the starting frequency, the output frequency of the inverter is the starting frequency. And then, the inverter will run from the starting frequency to the set frequency. If the set frequency is lower than the starting frequency, the inverter will stop running and keep in the stand-by state. The starting frequency is not limited in the lower limit frequency.	0.0s	⊙

Function code	Name	Detailed instruction of parameters	Default value	Modify
		<p>Setting range: 0.0~50.0s</p>		
P01.03	The braking current before starting	The inverter will carry out DC braking at the braking current set before starting and it will speed up after the DC braking time. If the DC braking time is set to 0, the DC braking is invalid.	0.0%	⊙
P01.04	The braking time before starting	The stronger the braking current, the bigger the braking power. The DC braking current before starting means the percentage of the rated current of the inverter. The setting range of P01.03: 0.0~100.0% The setting range of P01.04: 0.00~50.00s	0.00s	⊙
P01.05	ACC/DEC selection	The changing mode of the frequency during start-up and running. 0: Linear type The output frequency increases or decreases linearly.  	0	⊙
P01.06	ACC time of the starting step of S curve	0.0~50.0s	0.1s	○
P01.07	DEC time of the ending		0.1s	○

Function code	Name	Detailed instruction of parameters	Default value	Modify
	step of S curve			
P01.08	Stop mode	<p>0: Decelerate to stop: after the stop command becomes valid, the inverter decelerates to reduce the output frequency during the set time. When the frequency decreases to 0Hz, the inverter stops.</p> <p>1: Coast to stop: after the stop command becomes valid, the inverter ceases the output immediately. And the load coasts to stop at the mechanical inertia.</p>	0	<input type="radio"/>
P01.09	Starting frequency of DC braking	Starting frequency of DC braking: start the DC braking when running frequency reaches starting frequency determined by P1.09.	0.00Hz	<input type="radio"/>
P01.10	Waiting time before DC braking	Waiting time before DC braking: Inverters block the output before starting the DC braking. After this waiting time, the DC braking will be started so as to prevent over-current fault caused by DC braking at high speed.	0.00s	<input type="radio"/>
P01.11	DC braking current	DC braking current: The value of P01.11 is the percentage of rated current of inverter. The bigger the DC braking current is, the greater the braking torque is.	0.0%	<input type="radio"/>
P01.12	DC braking time	<p>DC braking time: The retention time of DC brake. If the time is 0, the DC brake is invalid. The inverter will stop at the set deceleration time.</p> <p>Setting range of P01.09: 0.00Hz~P00.03 (the Max. frequency)            Setting range of P01.10: 0.00~50.00s            Setting range of P01.11: 0.0~100.0%            Setting range of P01.12: 0.00~50.00s</p>	0.00s	<input type="radio"/>
P01.13	Dead time of FWD/REV rotation	During the procedure of switching FWD/REV rotation, set the threshold by P01.14, which is as the table below:	0.0s	<input type="radio"/>

Function code	Name	Detailed instruction of parameters	Default value	Modify
		<p>Setting range: 0.0~3600.0s</p>		
P01.14	Shifting between FWD/REV rotation	Set the threshold point of the inverter: 0:Switch after 0 frequency 1:Switch after the starting frequency 2:Switch after the stopping speed	0	⊙
P01.15	Stopping speed	0.00~100.00Hz	0.50 Hz	⊙
P01.16	Detection of stopping speed	0: Detect according to speed setting (no stopping delay) 1: Detect according to speed feedback (only valid for vector control)	1	⊙
P01.17	Detection time of the feedback speed	If set P01.16 to 1, the feedback frequency is less than or equal to P01.15 and detect in the set time of P01.17, the inverter will stop; otherwise the inverter will stop after the set time of P01.17 <p>Setting range: 0.00~100.00s (only valid when P01.16=1)</p>	0.50s	⊙
P01.18	Operation protection during powering on	When the running command channel is the terminal control, the system will detect the state of the running terminal during powering on. 0: The terminal running command is invalid when powering on. Even the running command is detected to be valid during powering on, the inverter won't run and the system keeps in the protection state until the running command is canceled and enabled again. 1: The terminal running command is valid when	0	○

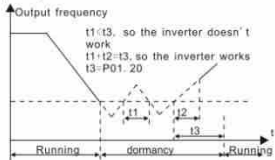
Function code	Name	Detailed instruction of parameters	Default value	Modify
		powering on. If the running command is detected to be valid during powering on, the system will start the inverter automatically after the initialization. <b>Note:</b> this function should be selected with cautions, or serious result may follow.		
P01.19	Action selection (operation frequency < lower frequency limit and valid when the lower limit > 0)	This function code determines the running state of the inverter when the set frequency is lower than the lower-limit one. 0: Run at the lower limit frequency 1: Stop 2: Hibernation The inverter will coast to stop when the set frequency is lower than the lower-limit one. If the set frequency is above the lower limit one again and it lasts for the time set by P01.20, the inverter will come back to the running state automatically.	0	⊙
P01.20	Hibernation restore delay time	This function code determines the hibernation delay time. When the running frequency of the inverter is lower than the lower limit one, the inverter will pause to stand by. When the set frequency is above the lower limit one again and it lasts for the time set by P01.20, the inverter will run automatically. <b>Note:</b> The time is the total value when the set frequency is above the lower limit one.  Setting range: 0.0~3600.0s (valid when P01.19=2)	0.0s	○
P01.21	Restart after power off	This function can enable the inverter start or not after the power off and then power on. 0: Disable 1: Enable, if the starting need is met, the inverter will run automatically after waiting for the time defined by P01.22.	0	○
P01.22	The waiting time of restart after power off	The function determines the waiting time before the automatic running of the inverter when powering off and then powering on.	1.0s	○

Function code	Name	Detailed instruction of parameters	Default value	Modify
		<p>Setting range: 0.0~3600.0s (valid when P01.21=1)</p>		
P01.23	Start delay time	The function determines the brake release after the running command is reference, and the inverter is in a stand-by state and wait for the delay time set by P01.23 Setting range: 0.0~60.0s	0.0s	<input type="radio"/>
P01.24	Delay time of the stop speed	<p>Setting range: 0.0~100.0 s</p>	0.0s	<input checked="" type="radio"/>
P01.25	0Hz output selection	0: Output without voltage 1: Output with voltage 2: Output at the DC braking current	0	<input checked="" type="radio"/>
<b>P02 Group Motor 1</b>				
P02.01	Rated power of AM 1	0.1~3000.0kW	Depend on model	<input checked="" type="radio"/>
P02.02	Rated frequency of AM 1	0.01Hz~P00.03(the Max. frequency)	50.00 Hz	<input checked="" type="radio"/>
P02.03	Rated speed of AM 1	1~36000rpm	Depend on model	<input checked="" type="radio"/>
P02.04	Rated voltage of AM 1	0~1200V	Depend on model	<input checked="" type="radio"/>
P02.05	Rated current of AM 1	0.8~6000.0A	Depend on model	<input checked="" type="radio"/>
P02.06	Stator resistor of AM 1	0.001~65.535Ω	Depend on model	<input type="radio"/>
P02.07	Rotor	0.001~65.535Ω	Depend	<input type="radio"/>

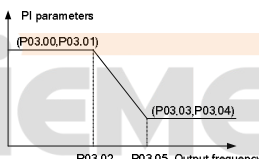

Function code	Name	Detailed instruction of parameters	Default value	Modify
	resistor of AM 1		on model	
P02.08	Leakage inductance of AM 1	0.1~6553.5mH	Depend on model	<input type="radio"/>
P02.09	Mutual inductance of AM 1	0.1~6553.5mH	Depend on model	<input type="radio"/>
P02.10	Non-load current of AM 1	0.1~6553.5A	Depend on model	<input type="radio"/>
P02.26	Motor 1 overload protection	<p>0: No protection</p> <p>1: Common motor (with low speed compensation). Because the heat-releasing effect of the common motors will be weakened, the corresponding electric heat protection will be adjusted properly. The low speed compensation characteristic mentioned here means reducing the threshold of the overload protection of the motor whose running frequency is below 30Hz.</p> <p>2: Variable frequency motor (without low speed compensation) Because the heat-releasing effect of the specific motors won't be impacted by the rotation speed, it is not necessary to adjust the protection value during low-speed running.</p>	2	<input checked="" type="radio"/>
P02.27	Motor 1 overload protection coefficient	<p>Times of motor overload <math>M = I_{out}/(I_n * K)</math></p> <p><math>I_n</math> is the rated current of the motor, <math>I_{out}</math> is the output current of the inverter and <math>K</math> is the motor protection coefficient.</p> <p>So, the bigger the value of <math>K</math> is, the smaller the value of <math>M</math> is. When <math>M = 116\%</math>, the fault will be reported after 1 hour, when <math>M = 200\%</math>, the fault will be reported after 1 minute, when <math>M \geq 400\%</math>, the fault will be reported instantly.</p>	100.0%	<input type="radio"/>

Function code	Name	Detailed instruction of parameters	Default value	Modify
		Setting range: 20.0%~120.0%		
P02.28	Correction coefficient of motor 1 power	Correct the power displaying of motor 1. Only impact the displaying value other than the control performance of the inverter. Setting range: 0.00~3.00	1.00	●
<b>P03 Group Vector control</b>				
P03.00	Speed loop proportional gain1	<p>The parameters P03.00~P03.05 only apply to vector control mode. Below the switching frequency 1(P03.02), the speed loop PI parameters are: P03.00 and P03.01. Above the switching frequency 2(P03.05), the speed loop PI parameters are: P03.03 and P03.04. PI parameters are gained according to the linear change of two groups of parameters. It is shown as below:</p> 	20.0	○
P03.01	Speed loop integral time1		0.200s	○
P03.02	Low switching frequency		5.00Hz	○
P03.03	Speed loop proportional gain 2		20.0	○
P03.04	Speed loop integral time 2		0.200s	○
P03.05	High switching frequency	<p>Setting the proportional coefficient and integral time of the adjustor can change the dynamic response performance of vector control speed loop. Increasing the proportional gain and decreasing the integral time can speed up the dynamic response of the speed loop. But too high proportional gain and too low integral time may cause system vibration and overshoot. Too low proportional gain may cause system vibration and speed static deviation.</p> <p>PI has a close relationship with the inertia of the system. Adjust on the base of PI according to different loads to meet various demands.</p> <p>The setting range of P03.00:0~200.0            The setting range of P03.01: 0.000~10.000s            The setting range of P03.02:0.00Hz~P03.05            The setting range of P03.03:0~200.0            The setting range of P03.04: 0.000~10.000s            The setting range of P03.05:P03.02~P00.03(the Max. output frequency)</p>	10.00Hz	○

Function code	Name	Detailed instruction of parameters	Default value	Modify
P03.06	Speed loop output filter	0~8 (corresponds to 0~2 <sup>8</sup> /10ms)	0	<input type="radio"/>
P03.07	Compensation coefficient of electro motion slip	Slip compensation coefficient is used to adjust the slip frequency of the vector control and improve the speed control accuracy of the system. Adjusting the parameter properly can control the speed steady-state error. Setting range:50~200%	100%	<input type="radio"/>
P03.08	Compensation coefficient of braking slip		100%	<input type="radio"/>
P03.09	Current loop percentage coefficient P	<b>Note:</b> 1 These two parameters adjust the PI adjustment parameter of the current loop which affects the dynamic response speed and control accuracy directly. Generally, users do not need to change the default value. 2 Only apply to SVC control mode 0(P00.00=0). Setting range:0~65535	1000	<input type="radio"/>
P03.10	Current loop integral coefficient 1		1000	<input type="radio"/>
P03.11	Torque setting method	This parameter is used to enable the torque control mode, and set the torque. 0:Torque control is invalid 1:Keypad setting torque(P03.12) 2:Analog AI1 setting torque(The inverter( ≤ 15kW) can be set by the analog potentiometer on the keypad and AI1 setting is not available for the device which is 18.5kW or higher than 18.5kW) 3:Analog AI2 setting torque 4:Analog AI3 setting torque 5:Pulse frequency HDI setting torque 6:Multi-step torque setting 7:MODBUS communication setting torque 8~10:Reserved Note: Setting modes 2~10, 100% corresponds to three times of the rated current of the motor.	0	<input type="radio"/>
P03.12	Keypad setting torque	Setting range: -300.0%~300.0%(rated current of the motor)	50.0%	<input type="radio"/>
P03.13	Torque reference filter time	0.000~10.000s	0.010s	<input type="radio"/>
P03.14	Upper frequency of	0:Keypad (P03.16 sets P03.14,P03.17 sets P03.15)	0	<input type="radio"/>

Function code	Name	Detailed instruction of parameters	Default value	Modify
	forward rotation in vector control	1: AI1 (The inverter( $\leq 15\text{kW}$ ) can be set by the analog potentiometer on the keypad and AI1 setting is not available for the device which is $18.5\text{kW}$ or higher than $18.5\text{kW}$ )		
P03.15	Upper frequency of reverse rotation in vector control	2: AI2 3: AI3 4:Pulse frequency HDI setting upper-limit frequency 5:Multi-step setting upper-limit frequency 6:MODBUS communication setting upper-limit frequency 7~ 9: Reserved Note: Setting method 1~9, 100% corresponds to the maximum frequency	0	<input type="radio"/>
P03.16	Keypad setting for upper frequency of forward rotation	This function is used to set the upper limit of the frequency. P03.16 sets the value of P03.14; P03.17 sets the value of P03.15. Setting range:0.00 Hz~P00.03 (the Max. output frequency)	50.00 Hz	<input type="radio"/>
P03.17	Keypad setting for upper frequency of reverse rotation		50.00Hz	<input type="radio"/>
P03.18	Upper electro motion torque source	This function code is used to select the electro motion and braking torque upper-limit setting source selection. 0:Keypad setting upper-limit frequency (P03.20 sets P03.18, P03.21 sets P03.19)	0	<input type="radio"/>
P03.19	Upper braking torque source	1: AI1 (The inverter( $\leq 15\text{kW}$ ) can be set by the analog potentiometer on the keypad and AI1 setting is not available for the device which is $18.5\text{kW}$ or higher than $18.5\text{kW}$ ) 2: AI2 3: AI3 4: HDI 5:MODBUS communication <b>Note:</b> setting mode 1~9,100% corresponds to three times of the motor current.	0	<input type="radio"/>

Function code	Name	Detailed instruction of parameters	Default value	Modify
P03.20	Keypad setting of electromotion torque	The function code is used to set the limit of the torque. Setting range:0.0~300.0%(motor rated current)	180.0%	<input type="radio"/>
P03.21	Keypad setting of braking torque		180.0%	<input type="radio"/>
P03.22	Weakening coefficient in constant power zone	<p>The usage of motor in weakening control.</p>	0.3	<input type="radio"/>
P03.23	Lowest weakening point in constant power zone	<p>Function code P03.22 and P03.23 are effective at constant power. The motor will enter into the weakening state when the motor runs at rated speed. Change the weakening curve by modifying the weakening control coefficient. The bigger the weakening control coefficient is, the steeper the weak curve is.</p> <p>The setting range of P03.22:0.1~2.0 The setting range of P03.23:10%~100%</p>	20%	<input type="radio"/>
P03.24	Max. voltage limit	P03.24 set the Max. Voltage of the inverter, which is dependent on the site situation. The setting range:0.0~120.0%	100.0%	<input checked="" type="radio"/>
P03.25	Pre-exciting time	Reactivate the motor when the inverter starts up. Build up a magnetic field inside the inverter to improve the torque performance during the starting process. The setting time:0.000~10.000s	0.300s	<input type="radio"/>
P03.26	Weak magnetic proportional gain	0~8000 <b>Note:</b> P03.24~P03.26 are invalid for vector mode.	1000	<input type="radio"/>
P03.27	Vector control speed	0: Display the actual value 1: Display the setting value	0	<input type="radio"/>
P03.28	Compensation coefficient of static	0.0~100.0% Adjust P03.28 to compensate the coefficient of static friction. Only valid when setting in 1Hz.	0.0%	<input type="radio"/>

Function code	Name	Detailed instruction of parameters	Default value	Modify
	friction			
P03.29	Compensation coefficient of dynamic friction	0.0~100.0% Adjust P03.29 to compensate the coefficient of static friction. Only valid when setting in 1Hz.	0.0%	<input type="radio"/>
<b>P04 Group SVPWM control</b>				
P04.00	Motor 1 V/F curve setting	<p>These function codes define the V/F curve of MS1200A motor 1, and meet the need of different loads.</p> <p>0: Straight line V/F curve; applying to the constant torque load</p> <p>1: Multi-dots V/F curve</p> <p>2: 1.3<sup>th</sup> power low torque V/F curve</p> <p>3: 1.7<sup>th</sup> power low torque V/F curve</p> <p>4: 2.0<sup>th</sup> power low torque V/F curve</p> <p>Curves 2~4 apply to the torque loads such as fans and water pumps. Users can adjust according to the features of the loads to achieve a best energy-saving effect.</p> <p>5: Customized V/F(V/F separation); in this mode, V can be separated from f and f can be adjusted through the frequency reference channel set by P00.06 or the voltage reference channel set by P04.27 to change the feature of the curve.</p> <p><b>Note:</b> <math>V_b</math> in the below picture is the motor rated voltage and <math>f_b</math> is the motor rated frequency.</p>	0	<input type="radio"/>

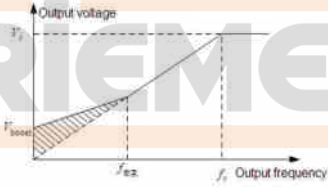
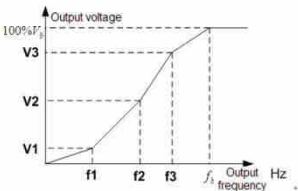
Function code	Name	Detailed instruction of parameters	Default value	Modify
P04.01	Motor 1 torque boost	<p>Torque boost is used for the compensation of low frequency torque. P04.01 is relative to the Max. output voltage <math>V_b</math>.</p> <p>P04.02 defines the percentage of closing frequency of manual torque to <math>f_b</math>.</p> <p>Torque boost should be selected according to the load. The bigger the load is, the bigger the torque is. Too big torque boost is inappropriate because the motor will run with over magnetic, and the current of the inverter will increase to add the temperature of the inverter and decrease the efficiency.</p> <p>When the torque boost is set to 0.0%, the inverter is automatic torque boost.</p>	0.0%	<input type="radio"/>
P04.02	Motor 1 torque boost close	<p>Torque boost threshold: below this frequency point, the torque boost is effective, but over this frequency point, the torque boost is invalid.</p>  <p>The setting range of P04.01:0.0%:(automatic) 0.1%~10.0%</p> <p>The setting range of P04.02:0.0%~50.0%</p>	20.0%	<input type="radio"/>
P04.03	V/F frequency 1 of motor 1	 <p>When P04.00 = 1, the user can set V/F curve through P04.03~P04.08.</p> <p>V/F is generally set according to the load of the motor.</p> <p><b>Note:</b> <math>V1 &lt; V2 &lt; V3</math>, <math>f1 &lt; f2 &lt; f3</math>. Too high low frequency voltage will heat the motor excessively</p>	0.00Hz	<input type="radio"/>
P04.04	V/F voltage 1 of motor 1		00.0%	<input type="radio"/>
P04.05	V/F frequency 2 of motor 1		00.00Hz	<input type="radio"/>
P04.06	V/F voltage 2 of motor 1		00.0%	<input type="radio"/>
P04.07	V/F frequency 3 of motor 1		00.00Hz	<input type="radio"/>
P04.08	V/F voltage 3		00.0%	<input type="radio"/>

Function code	Name	Detailed instruction of parameters	Default value	Modify
	of motor 1	or damage. The inverter may occur the overcurrent speed or overcurrent protection. The setting range of P04.03: 0.00Hz~P04.05 The setting range of P04.04:0.0%~110.0% The setting range of P04.05:P04.03~ P04.07 The setting range of P04.06:0.0%~110.0% (the rated voltage of motor 1) The setting range of P04.07:P04.05~ P02.02 (the rated frequency of motor 1) The setting range of P04.08:0.0%~110.0% (the rated voltage of motor 1)		
P04.09	V/F slip compensation gain of motor 1	This function code is used to compensate the change of the rotation speed caused by load during compensation SVPWM control to improve the rigidity of the motor. It can be set to the rated slip frequency of the motor which is counted as below: $\Delta f = f_b - n * p / 60$ Of which, $f_b$ is the rated frequency of the motor, its function code is P02.02; $n$ is the rated rotating speed of the motor and its function code is P02.03; $p$ is the pole pair of the motor. 100.0% corresponds to the rated slip frequency $\Delta f$ . Setting range:0.0~200.0%	100.0%	<input type="radio"/>
P04.10	Motor 1 low frequency vibration control factor	In the SVPWM control mode, current fluctuation may occur to the motor on some frequency, especially the motor with big power. The motor	10	<input type="radio"/>
P04.11	Motor 1 high frequency vibration control factor	can not run stably or overcurrent may occur. These phenomena can be canceled by adjusting this parameter. The setting range of P04.10:0~100 The setting range of P04.11:0~100	10	<input type="radio"/>
P04.12	Motor 1 vibration control threshold	The setting range of P04.12:0.00Hz~P00.03 (the Max. frequency)	30.00 Hz	<input type="radio"/>
P04.26	Energy-saving operation selection	0:No action 1:Automatic energy-saving operation Motor on the light load conditions, automatically adjusts the output voltage to save energy	0	<input checked="" type="radio"/>
P04.27	Voltage	Select the output setting channel at V/F curve	0	<input type="radio"/>

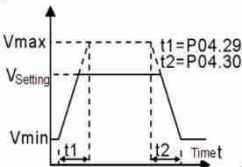

Function code	Name	Detailed instruction of parameters	Default value	Modify
	setting channel	separation. 0: Keypad setting voltage: the output voltage is determined by P04.28. 1:AI1 setting voltage(The inverter( $\leq 15kW$ ) can be set by the analog potentiometer on the keypad and AI1 setting is not available for the device which is 18.5kW or higher than 18.5kW) 2:AI2 setting voltage; 3:AI3 setting voltage; 4:HDI setting voltage; 5:Multi-step speed setting voltage; 6:PID setting voltage; 7:MODBUS communication setting voltage; <b>Note:</b> 100% corresponds to the rated voltage of the motor.		
P04.28	Keypad setting voltage	The function code is the voltage digital set value when the voltage setting channel is selected as "keypad selection" The setting range:0.0%~100.0%	100.0%	<input type="radio"/>
P04.29	Voltage increasing time	Voltage increasing time is the time when the inverter accelerates from the output minimum voltage to the output maximum voltage.	5.0s	<input type="radio"/>
P04.30	Voltage decreasing time	Voltage decreasing time is the time when the inverter decelerates from the output maximum voltage to the output minimum voltage. The setting range:0.0~3600.0s	5.0s	<input type="radio"/>
P04.31	Maximum output voltage	Set the upper and low limit of the output voltage. The setting range of P04.31:P04.32~100.0% (the rated voltage of the motor)	100.0%	<input checked="" type="radio"/>
P04.32	Minimum output voltage	The setting range of P04.32:0.0%~ P04.31 (the rated voltage of the motor) 	0.0%	<input checked="" type="radio"/>
P04.33	Weaking coefficient at constant	Used to adjust the output voltage of inverter in SVPWM mode when weakening magnetic. <b>Note:</b> Invalid in constant-torque mode.	1.00	<input checked="" type="radio"/>

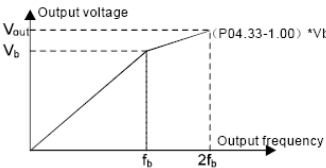
Function code	Name	Detailed instruction of parameters	Default value	Modify
	power	 <p>The setting range of P04.33: 1.00~1.30</p>		

### P05 Group Input terminals

P05.00	HDI input	0: HDI is high pulse input. See P05.49~P05.54 1: HDI is switch input	0	⊙
P05.01	S1 terminal function selection	0: No function 1: Forward rotation 2: Reverse rotation	1	⊙
P05.02	S2 terminal function selection	3: 3-wire control 4: Forward jogging 5: Reverse jogging	4	⊙
P05.03	S3 terminal function selection	6: Coast to stop 7: Fault reset 8: Operation pause 9: External fault input	7	⊙
P05.04	S4 terminal function selection	10: Increasing frequency setting(UP) 11: Decreasing frequency setting(DOWN)	0	⊙
P05.05	S5 terminal function selection	12: Cancel the frequency change setting 13: Shift between A setting and B setting 14: Shift between combination setting and A setting	0	⊙
P05.06	S6 terminal function selection	15: Shift between combination setting and B setting	0	⊙
P05.07	S7 terminal function selection	16: Multi-step speed terminal 1 17: Multi-step speed terminal 2 18: Multi-step speed terminal 3 19: Multi- step speed terminal 4	0	⊙
P05.08	S8 terminal function selection	20: Multi- step speed pause 21: ACC/DEC time option 1 22: ACC/DEC time option 2	0	⊙
P05.09	HDI terminal function selection	23: Simple PLC stop reset 24: Simple PLC pause 25: PID control pause 26: Traverse Pause(stop at the current frequency) 27: Traverse reset(return to the center frequency)	0	⊙

Function code	Name	Detailed instruction of parameters	Default value	Modify																				
		28:Counter reset 29:Torque control prohibition 30:ACC/DEC prohibition 31:Counter trigger 32:Length reset 33:Cancel the frequency change setting temporarily 34:DC brake 36:Shift the command to the keypad 37:Shift the command to the terminals 38:Shift the command to the communication 39: Pre-exciting command 40:Clear the power 41:Keep the power 61: PID pole switching																						
P05.10	Polarity selection of the input terminals	The function code is used to set the polarity of the input terminals. Set the bit to 0, the input terminal is anode. Set the bit to 1, the input terminal is cathode. <table border="1" style="margin-left: auto; margin-right: auto;"> <tr> <td>BIT0</td><td>BIT1</td><td>BIT2</td><td>BIT3</td><td>BIT4</td></tr> <tr> <td>S1</td><td>S2</td><td>S3</td><td>S4</td><td>S5</td></tr> <tr> <td>BIT5</td><td>BIT6</td><td>BIT7</td><td>BIT8</td><td></td></tr> <tr> <td>S6</td><td>S7</td><td>S8</td><td>HDI</td><td></td></tr> </table> The setting range:0x000~0x1FF	BIT0	BIT1	BIT2	BIT3	BIT4	S1	S2	S3	S4	S5	BIT5	BIT6	BIT7	BIT8		S6	S7	S8	HDI		0x000	○
BIT0	BIT1	BIT2	BIT3	BIT4																				
S1	S2	S3	S4	S5																				
BIT5	BIT6	BIT7	BIT8																					
S6	S7	S8	HDI																					
P05.11	ON-OFF filter time	Set the sample filter time of S1~S8 and HDI terminals. If the interference is strong, increase the parameter to avoid the disoperation. 0.000~1.000s	0.010s	○																				
P05.12	Virtual terminals setting	0x000~0x1FF(0: Disabled, 1:Enabled ) BIT0:S1 virtual terminal BIT1:S2 virtual terminal BIT2:S3 virtual terminal BIT3:S4 virtual terminal BIT4:S5 virtual terminal BIT5:S6 virtual terminal BIT6:S7 virtual terminal BIT7:S8 virtual terminal BIT8:HDI virtual terminal	0x000	◎																				
P05.13	Terminals control running	Set the operation mode of the terminals control 0:2-wire control 1, comply the enable with the direction. This mode is widely used. It determines	0	◎																				

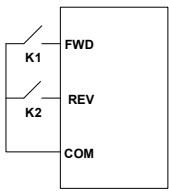
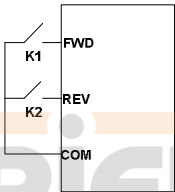
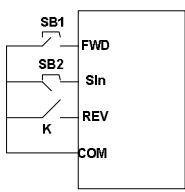
Function code	Name	Detailed instruction of parameters	Default value	Modify																																																				
	mode	<p>the rotation direction by the defined FWD and REV terminals command.</p> <div style="display: flex; align-items: center;">  <table border="1" style="margin-left: 20px;"> <thead> <tr> <th>FWD</th> <th>REV</th> <th>运行命令</th> </tr> </thead> <tbody> <tr> <td>OFF</td> <td>OFF</td> <td>停止</td> </tr> <tr> <td>ON</td> <td>OFF</td> <td>正转运行</td> </tr> <tr> <td>OFF</td> <td>ON</td> <td>反转运行</td> </tr> <tr> <td>ON</td> <td>ON</td> <td>保持</td> </tr> </tbody> </table> </div> <p>1:2-wire control 2; Separate the enable from the direction. FWD defined by this mode is the enabling ones. The direction depends on the state of the defined REV.</p> <div style="display: flex; align-items: center;">  <table border="1" style="margin-left: 20px;"> <thead> <tr> <th>FWD</th> <th>REV</th> <th>运行命令</th> </tr> </thead> <tbody> <tr> <td>OFF</td> <td>OFF</td> <td>停止</td> </tr> <tr> <td>ON</td> <td>OFF</td> <td>正转运行</td> </tr> <tr> <td>OFF</td> <td>ON</td> <td>停止</td> </tr> <tr> <td>ON</td> <td>ON</td> <td>反转运行</td> </tr> </tbody> </table> </div> <p>2:3-wire control 1; Sin is the enabling terminal on this mode, and the running command is caused by FWD and the direction is controlled by REV. Sin is natural closed.</p> <div style="display: flex; align-items: center;">  </div> <p>The direction control is as below during operation:</p> <table border="1" style="width: 100%; text-align: center;"> <thead> <tr> <th>Sin</th> <th>REV</th> <th>Previous direction</th> <th>Current direction</th> </tr> </thead> <tbody> <tr> <td rowspan="2">ON</td> <td rowspan="2">OFF→ON</td> <td>Forward</td> <td>Reverse</td> </tr> <tr> <td>Reverse</td> <td>Forward</td> </tr> <tr> <td rowspan="2">ON</td> <td rowspan="2">ON→OFF</td> <td>Reverse</td> <td>Forward</td> </tr> <tr> <td>Forward</td> <td>Reverse</td> </tr> <tr> <td>ON→OFF</td> <td>ON</td> <td colspan="2" rowspan="2">Decelerate to stop</td> </tr> <tr> <td>OFF</td> <td>OFF</td> </tr> </tbody> </table>	FWD	REV	运行命令	OFF	OFF	停止	ON	OFF	正转运行	OFF	ON	反转运行	ON	ON	保持	FWD	REV	运行命令	OFF	OFF	停止	ON	OFF	正转运行	OFF	ON	停止	ON	ON	反转运行	Sin	REV	Previous direction	Current direction	ON	OFF→ON	Forward	Reverse	Reverse	Forward	ON	ON→OFF	Reverse	Forward	Forward	Reverse	ON→OFF	ON	Decelerate to stop		OFF	OFF		
FWD	REV	运行命令																																																						
OFF	OFF	停止																																																						
ON	OFF	正转运行																																																						
OFF	ON	反转运行																																																						
ON	ON	保持																																																						
FWD	REV	运行命令																																																						
OFF	OFF	停止																																																						
ON	OFF	正转运行																																																						
OFF	ON	停止																																																						
ON	ON	反转运行																																																						
Sin	REV	Previous direction	Current direction																																																					
ON	OFF→ON	Forward	Reverse																																																					
		Reverse	Forward																																																					
ON	ON→OFF	Reverse	Forward																																																					
		Forward	Reverse																																																					
ON→OFF	ON	Decelerate to stop																																																						
OFF	OFF																																																							

Function code	Name	Detailed instruction of parameters	Default value	Modify																									
		<p>3:3-wire control 2; Sin is the enabling terminal on this mode, and the running command is caused by SB1 or SB3 and both of them control the running direction. NC SB2 generates the stop command.</p> <table border="1" style="margin-left: auto; margin-right: auto;"> <thead> <tr> <th>Sin</th> <th>FWD</th> <th>REV</th> <th>Direction</th> </tr> </thead> <tbody> <tr> <td rowspan="2">ON</td> <td>OFF →</td> <td>ON</td> <td>Forward</td> </tr> <tr> <td>ON</td> <td>OFF</td> <td>Reverse</td> </tr> <tr> <td rowspan="2">ON</td> <td>ON</td> <td>OFF →</td> <td>Forward</td> </tr> <tr> <td>OFF</td> <td>ON</td> <td>Reverse</td> </tr> <tr> <td>ON →</td> <td></td> <td></td> <td rowspan="2">Decelerate to stop</td> </tr> <tr> <td>OFF</td> <td></td> <td></td> </tr> </tbody> </table> <p><b>Note:</b> for the 2-wire running mode, when FWD/REV terminal is valid, the inverter stop because of the stopping command from other sources, even the control terminal FWD/REV keeps valid; the inverter won't work when the stopping command is canceled. Only when FWD/REV is relaunched, the inverter can start again. For example, the valid STOP/RST stop when PLC signal cycles stop, fixed-length stop and terminal control (see P07.04).</p>	Sin	FWD	REV	Direction	ON	OFF →	ON	Forward	ON	OFF	Reverse	ON	ON	OFF →	Forward	OFF	ON	Reverse	ON →			Decelerate to stop	OFF				
Sin	FWD	REV	Direction																										
ON	OFF →	ON	Forward																										
	ON	OFF	Reverse																										
ON	ON	OFF →	Forward																										
	OFF	ON	Reverse																										
ON →			Decelerate to stop																										
OFF																													
P05.14	S1 terminal switching-on delay time	The function code defines the corresponding delay time of electrical level of the programmable terminals from switching on to switching off.	0.000s	<input type="radio"/>																									
P05.15	S1 terminal switching-off delay time		0.000s	<input type="radio"/>																									
P05.16	S2 terminal switching-on delay time	Setting range:0.000~50.000s	0.000s	<input type="radio"/>																									

Function code	Name	Detailed instruction of parameters	Default value	Modify
P05.17	S2 terminal switching-off delay time		0.000s	<input type="radio"/>
P05.18	S3 terminal switching-on delay time		0.000s	<input type="radio"/>
P05.19	S3 terminal switching-off delay time		0.000s	<input type="radio"/>
P05.20	S4 terminal switching-on delay time		0.000s	<input type="radio"/>
P05.21	S4 terminal switching-off delay time		0.000s	<input type="radio"/>
P05.22	S5 terminal switching-on delay time		0.000s	<input type="radio"/>
P05.23	S5 terminal switching-off delay time		0.000s	<input type="radio"/>
P05.24	S6 terminal switching-on delay time		0.000s	<input type="radio"/>
P05.25	S6 terminal switching-off delay time		0.000s	<input type="radio"/>
P05.26	S7 terminal switching-on delay time		0.000s	<input type="radio"/>
P05.27	S7 terminal switching-off		0.000s	<input type="radio"/>

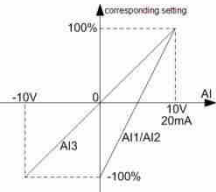
Function code	Name	Detailed instruction of parameters	Default value	Modify
	delay time			
P05.28	S8 terminal switching-on delay time		0.000s	<input type="radio"/>
P05.29	S8 terminal switching-off delay time		0.000s	<input type="radio"/>
P05.30	HDI terminal switching-on delay time		0.000s	<input type="radio"/>
P05.31	HDI terminal switching-off delay time		0.000s	<input type="radio"/>
P05.32	Lower limit of AI1	The inverter( $\leq 15\text{kW}$ ) can be set by the analog potentiometer on the keypad and AI1 setting is not available for the device which is 18.5kW or higher than 18.5 kW.	0.00V	<input type="radio"/>
P05.33	Corresponding setting of the lower limit of AI1	The function code defines the relationship between the analog input voltage and its corresponding set value. If the analog input voltage beyond the set minimum or maximum input value, the inverter will count at the minimum or maximum one.	0.0%	<input type="radio"/>
P05.34	Upper limit of AI1	When the analog input is the current input, the corresponding voltage of 0~20mA is 0~10V.	10.00V	<input type="radio"/>
P05.35	Corresponding setting of the upper limit of AI1	In different cases, the corresponding rated value of 100.0% is different. See the application for detailed information.	100.0%	<input type="radio"/>
P05.36	AI1 input filter time		0.100s	<input type="radio"/>
P05.37	Lower limit of AI2	The figure below illustrates different applications:	0.00V	<input type="radio"/>
P05.38	Corresponding setting of the lower limit of AI2		0.0%	<input type="radio"/>
P05.39	Upper limit of AI2		10.00V	<input type="radio"/>
P05.40	Corresponding setting of		Input filter time: this parameter is used to adjust	100.0%

Function code	Name	Detailed instruction of parameters	Default value	Modify
	the upper limit of AI2	the sensitivity of the analog input. Increasing the value properly can enhance the anti-interference of the analog, but weaken the sensitivity of the analog input		
P05.41	AI2 input filter time		0.100s	<input type="radio"/>
P05.42	Lower limit of AI3	<b>Note:</b> Analog AI1 and AI2 can support 0~10V or 0~20mA input, when AI1 and AI2 selects 0~20mA input, the corresponding voltage of 20mA is 5V.	-10.00V	<input type="radio"/>
P05.43	Corresponding setting of the lower limit of AI3	AI3 can support the output of -10V~+10V. The setting range of P05.32:P05.32~P05.34 The setting range of P05.33:-100.0%~100.0%	-100.0%	<input type="radio"/>
P05.44	Middle value of AI3	The setting range of P05.34:P05.32~10.00V The setting range of P05.35:-100.0%~100.0%	0.00V	<input type="radio"/>
P05.45	Corresponding middle setting of AI3	The setting range of P05.36:0.000s~10.000s The setting range of P05.37:0.00V~P05.39 The setting range of P05.38:-100.0%~100.0% The setting range of P05.39:P05.37~10.00V	0.0%	<input type="radio"/>
P05.46	Upper limit of AI3	The setting range of P05.40:-100.0%~100.0% The setting range of P05.41:0.000s~10.000s	10.00V	<input type="radio"/>
P05.47	Corresponding setting of the upper limit of AI3	The setting range of P05.42:-10.00V~P05.44 The setting range of P05.43:-100.0%~100.0% The setting range of P05.44: P05.42~P05.46 The setting range of P05.45:-100.0%~100.0%	100.0%	<input type="radio"/>
P05.48	AI3 input filter time	The setting range of P05.46:P05.44~10.00V The setting range of P05.47:-100.0%~100.0% The setting range of P05.48:0.000s~10.000s	0.100s	<input type="radio"/>
P05.49	HDI high-speed pulse input	The function selection when HDI terminals is high-speed pulse input 0:Frequency setting input, frequency setting source 1:Counter input, high-speed pulse counter input terminals 2:Length counting input, length counter input terminals	0	<input checked="" type="radio"/>
P05.50	Lower limit frequency of HDI	0.000kHz~P05.52	0.000 kHz	<input type="radio"/>
P05.51	Corresponding setting of HDI low frequency setting	-100.0%~100.0%	0.0%	<input type="radio"/>

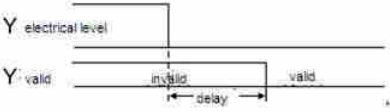

Function code	Name	Detailed instruction of parameters	Default value	Modify
P05.52	Upper limit frequency of HDI	P05.50 ~50.00kHz	50.00 kHz	<input type="radio"/>
P05.53	Corresponding setting of upper limit frequency of HDI	-100.0%~100.0%	100.0%	<input type="radio"/>
P05.54	HDI frequency input filter time	0.000s~10.000s	0.100s	<input type="radio"/>
<b>P06 Group Output terminals</b>				
P06.00	HDO output	The function selection of the high-speed pulse output terminals. 0: Open collector pole high speed pulse output: The Max.pulse frequency is 50.0kHz. See P06.27~P06.31 for detailed information of the related functions. 1: Open collector pole output. See P06.02 for detailed information of the related functions.	0	<input checked="" type="radio"/>
P06.01	Y1 output	0:Invalid	0	<input type="radio"/>
P06.02	HDO output	1:In operation	0	<input type="radio"/>
P06.03	Relay RO1 output	2:Forward rotation 3:Reverse rotation	1	<input type="radio"/>
P06.04	Relay RO2 output	4: Jogging 5:The inverter fault 6:Frequency degree test FDT1 7:Frequency degree test FDT2 8:Frequency arrival 9:Zero speed running 10:Upper limit frequency arrival 11:Lower limit frequency arrival 12:Ready for operation 13:Pre-magnetizing 14:Overload pre-alarm 15: Underload pre-alarm 16:Completion of simple PLC step 17:Completion of simple PLC cycle 18:Setting count value arrival 19:Defined count value arrival	5	<input type="radio"/>

Function code	Name	Detailed instruction of parameters	Default value	Modify								
		20: External fault valid 21: Length arrival 22: Running time arrival 23: MODBUS communication virtual terminals output 26: DC bus voltage establishment 27: Auxiliary motor 1 28: Auxiliary motor 2										
P06.05	Polarity selection of output terminals	The function code is used to set the pole of the output terminal. When the current bit is set to 0, input terminal is positive. When the current bit is set to 1, input terminal is negative. <table border="1" style="margin: 10px auto;"> <tr> <td>BIT0</td> <td>BIT1</td> <td>BIT2</td> <td>BIT3</td> </tr> <tr> <td>Y</td> <td>HDO</td> <td>RO1</td> <td>RO2</td> </tr> </table> Setting range: 0~F	BIT0	BIT1	BIT2	BIT3	Y	HDO	RO1	RO2	0	<input type="radio"/>
BIT0	BIT1	BIT2	BIT3									
Y	HDO	RO1	RO2									
P06.06	Y1 switching-on delay time		0.000s	<input type="radio"/>								
P06.07	Y1 switching-off delay time		0.000s	<input type="radio"/>								
P06.08	HDO switching-on delay time		0.000s	<input type="radio"/>								
P06.09	HDO switching-off delay time		0.000s	<input type="radio"/>								
P06.10	RO1 switching-on delay time		0.000s	<input type="radio"/>								
P06.11	RO1 switching-off delay time		0.000s	<input type="radio"/>								
P06.12	RO2 switching-on delay time		0.000s	<input type="radio"/>								
P06.13	RO2 switching-off delay time		0.000s	<input type="radio"/>								

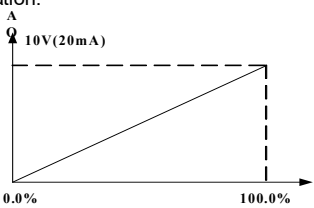
Function code	Name	Detailed instruction of parameters	Default value	Modify
P06.14	AO1 output	0:Running frequency	0	<input type="radio"/>
P06.15	AO2 output	1:Setting frequency	0	<input type="radio"/>
P06.16	HDO high-speed pulse output selection	2:Ramp reference frequency	0	<input type="radio"/>
		3:Running rotation speed		
		4:Output current (relative to the rated current of the inverter)		
		5:Output current (relative to the rated current of the motor)		
		6:Output voltage		
		7:Output power		
		9:Output torque		
		10:Analog AI1 input value (The inverter( $\leq 15\text{kW}$ ) can be set by the analog potentiometer on the keypad and AI1 setting is not available for the device which is 18.5kW or higer than 18.5 kW)	0	<input type="radio"/>
		11:Analog AI2 input value		
		12:Analog AI3 input value		
		13:High speed pulse HDI input value		
		14:MODBUS communication set value 1		
		15:MODBUS communication set value 2		
		22: Torque current (relative to the rated current of the motor)		
		23: Ramp reference frequency(with sign)		
P06.17	Lower limit of AO1 output	The above function codes define the relative relationship between the output value and analog output. When the output value exceeds the range of set maximum or minimum output, it will count according to the low-limit or upper-limit output. When the analog output is current output, 1mA equals to 0.5V.	0.0%	<input type="radio"/>
P06.18	Corresponding AO1 output to the lower limit		0.00V	<input type="radio"/>
P06.19	Upper limit of AO1 output	In different cases, the corresponding analog output of 100% of the output value is different. Please refer to each application for detailed information.	100.0%	<input type="radio"/>
P06.20	The corresponding AO1 output to the upper limit		10.00V	<input type="radio"/>
P06.21	AO1 output filter time		0.000s	<input type="radio"/>
P06.22	Lower limit of AO2 output		0.0%	<input type="radio"/>
P06.23	Correspondin		0.00V	<input type="radio"/>

Function code	Name	Detailed instruction of parameters	Default value	Modify
	g AO2 output to the lower limit	Setting range of P06.18 0.00V~10.00V Setting range of P06.19 P06.17~100.0% Setting range of P06.20 0.00V~10.00V		
P06.24	Upper limit of AO2 output	Setting range of P06.21 0.000s~10.000s Setting range of P06.22 0.0%~P06.24	100.0%	<input type="radio"/>
P06.25	Corresponding AO2 output to the upper limit	Setting range of P06.23 0.00V~10.00V Setting range of P06.24 P06.22~100.0% Setting range of P06.25 0.00V~10.00V Setting range of P06.26 0.000s~10.000s	10.00V	<input type="radio"/>
P06.26	AO2 output filter time	Setting range of P06.27 0.000s~10.000s Setting range of P06.28 0.00~50.00kHz	0.000s	<input type="radio"/>
P06.27	Lower limit of HDO output	Setting range of P06.29 P06.27~100.0% Setting range of P06.30 0.00~50.00kHz	0.00%	<input type="radio"/>
P06.28	Corresponding HDO output to the lower limit	Setting range of P06.31 0.000s~10.000s	0.00kHz	<input type="radio"/>
P06.29	Upper limit of HDO output		100.0%	<input type="radio"/>
P06.30	Corresponding HDO output to the upper limit		50.00 kHz	<input type="radio"/>
P06.31	HDO output filter time		0.000s	<input type="radio"/>
<b>P07 Group Human-Machine Interface</b>				
P07.00	User's password	0~65535 The password protection will be valid when setting any non-zero number. 00000: Clear the previous user's password, and make the password protection invalid. After the user's password becomes valid, if the password is incorrect, users cannot enter the parameter menu. Only correct password can make the user check or modify the parameters. Please remember all users' passwords. Retreat editing state of the function codes and the password protection will become valid in 1 minute. If the password is available, press <b>PRG/ESC</b> to enter into the editing state of the function codes, and then "0.0.0.0.0" will be	0	<input type="radio"/>

Function code	Name	Detailed instruction of parameters	Default value	Modify
		displayed. Unless input right password, the operator can not enter into it. <b>Note:</b> Restoring to the default value can clear the password, please use it with caution.		
P07.01	Parameter copy	The function code determines the mode of parameters copy. 0:No operation 1:Upload the local function parameter to the keypad 2:Download the keypad function parameter to local address(including the motor parameters) 3:Download the keypad function parameter to local address (excluding the motor parameter of P02 group) 4:Download the keypad function parameters to local address (only for the motor parameter of P02 group) <b>Note:</b> After completing the 1~4 operation, the parameter will come back to 0 automatically, the function of upload and download excludes the factory parameters of P29.	0	©
P07.02	<u>QUICK/JOG</u> function selection	0:No function 1: Jogging. Press <u>QUICK/JOG</u> to begin the jogging running. 2: Shift the display state by the shifting key. Press <u>QUICK/JOG</u> to shift the displayed function code from right to left. 3: Shift between forward rotations and reverse rotations. Press <u>QUICK/JOG</u> to shift the direction of the frequency commands. This function is only valid in the keypad commands channels. 4: Clear UP/DOWN settings. Press <u>QUICK/JOG</u> to clear the set value of UP/DOWN. 5: Coast to stop. Press <u>QUICK/JOG</u> to coast to stop. 6: Shift the running commands source. Press <u>QUICK/JOG</u> to shift the running commands source. 7:Quick commission mode(committee according to the non-factory parameter) <b>Note:</b> Press <u>QUICK/JOG</u> to shift between forward rotation and reverse rotation, the inverter	1	©

Function code	Name	Detailed instruction of parameters	Default value	Modify
		does not record the state after shifting during powering off. The inverter will run according to parameter P00.13 during next powering on.		
P07.03	Shifting sequence selection of <b>QUICK/JOG</b> commands	When P07.02=6, set the shifting sequence of running command channels. 0:Keypad control→terminals control →communication control 1:Keypad control←→terminals control 2:Keypad control←→communication control 3:Terminals control←→communication control	0	○
P07.04	<b>STOP/RST</b> stop function	<b>STOP/RST</b> is valid for stop function. <b>STOP/RST</b> is valid in any state for the fault reset. 0:Only valid for the keypad control 1:Both valid for keypad and terminals control 2:Both valid for keypad and communication control 3:Valid for all control modes	0	○
P07.05	Parameters state 1	0x0000~0xFFFF BIT0:running frequency (Hz on) BIT1:set frequency(Hz flickering) BIT2:bus voltage (Hz on) BIT3:output voltage(V on) BIT4:output current(A on) BIT5:running rotation speed (rpm on) BIT6:output power(% on) BIT7:output torque(% on) BIT8:PID reference(% flickering) BIT9:PID feedback value(% on) BIT10:input terminals state BIT11:output terminals state BIT12:torque set value(% on) BIT13:pulse counter value BIT14:length value BIT15:PLC and the current stage in multi-step speed	0x03FF	○
P07.06	Parameters state 2	0x0000~0xFFFF BIT0: AI1 (V on) (The inverter(≤ 15kW) can be set by the analog potentiometer on the keypad and AI1 setting is not available for the device which is 18.5kW or higer than 18.5 kW) BIT1: AI2 (V on) BIT2: AI3 (V on)	0x0000	

Function code	Name	Detailed instruction of parameters	Default value	Modify
		BIT3: HDI frequency BIT4: motor overload percentage (% on) BIT5: the inverter overload percentage (% on) BIT6: ramp frequency given value(Hz on) BIT7: linear speed BIT8: AC inlet current (A on) BIT9: upper limit frequency (Hz on)		
P07.07	The parameter in the stop state	0x0000~0xFFFF BIT0:set frequency (Hz on, frequency flickering slowly) BIT1:bus voltage (V on) BIT2:input terminals state BIT3:output terminals state BIT4:PID reference (% flickering) BIT5:PID feedback value(% flickering) BIT6:reserved BIT7:analog AI1 value(V on) (The inverter( $\leq$ 15kW) can be set by the analog potentiometer on the keypad and AI1 setting is not available for the device which is 18.5kW or higer than 18.5 kW) BIT8:analog AI2 value(V on) BIT9: analog AI3 value(V on) BIT10:high speed pulse HDI frequency BIT11:PLC and the current step in multi-step speed BIT12:pulse counters BIT13:length value BIT14: upper limit frequency (Hz on)	0x00FF	<input type="radio"/>
P07.08	Frequency coefficient	0.01~10.00 Displayed frequency=running frequency* P07.08	1.00	<input type="radio"/>
P07.09	Rotation speed coefficient	0.1~999.9% Mechanical rotation speed =120*displayed running frequency*P07.09/motor pole pairs	100.0%	<input type="radio"/>
P07.10	Linear speed coefficient	0.1~999.9% Linear speed= Mechanical rotation speed*P07.10	1.0%	<input type="radio"/>
P07.11	Rectifier bridge module temperature	0~100.0°C		<input checked="" type="radio"/>
P07.12	Converter	0~100.0°C		<input checked="" type="radio"/>

Function code	Name	Detailed instruction of parameters	Default value	Modify
	module temperature			
P07.13	Software version	1.00~655.35		●
P07.14	Local accumulative running time	0~65535h		●
P07.15	High bit of power consumption	Display the power used by the inverter. The power consumption of the inverter =P07.15*1000+P07.16		●
P07.16	Low bit of power consumption	Setting range of P07.15: 0~65535°(*1000) Setting range of P07.16: 0.0~999.9°		●
P07.17	Inverter type	0: G type 1: P type		●
P07.18	The rated power of the inverter	0.4~3000.0kW		●
P07.19	The rated voltage of the inverter	50~1200V		●
P07.20	The rated current of the inverter	0.1~6000.0A		●
P07.21	Factory bar code 1	0x0000~0xFFFF		●
P07.22	Factory bar code 2	0x0000~0xFFFF		●
P07.23	Factory bar code 3	0x0000~0xFFFF		●
P07.24	Factory bar code 4	0x0000~0xFFFF		●
P07.25	Factory bar code 5	0x0000~0xFFFF		●
P07.26	Factory bar code 6	0x0000~0xFFFF		●



Function code	Name	Detailed instruction of parameters	Default value	Modify
P07.27	Current fault type	0:No fault 1:IGBT U phase protection(OUT1) 2:IGBT V phase protection(OUT2) 3:IGBT W phase protection(OUT3) 4:OC1 5:OC2 6:OC3 7:OV1 8:OV2 9:OV3 10:UV 11:Motor overload(OL1) 12:The inverter overload(OL2) 13:Input side phase loss(SPI) 14:Output side phase loss(SPO) 15:Overheat of the rectifier module(OH1) 16:Overheat fault of the inverter module(OH2) 17:External fault(EF) 18:485 communication fault(CE) 19:Current detection fault(ItE) 20:Motor antotune fault(tE) 21:EEPROM operation fault(EEP) 22:PID response offline fault(PIDE) 23:Braking unit fault(bCE) 24:Running time arrival(END) 25:Electrical overload(OL3)		●
P07.28	Previous fault type	26:Panel communication fault(PCE) 27:Parameter uploading fault (UPE) 28:Parameter downloading fault(DNE) 32:Grounding short circuit fault 1(ETH1) 33:Grounding short circuit fault 2(ETH2) 36: Undervoltage fault(LL)		●
P07.29	Previous 2 fault type			●
P07.30	Previous 3 fault type			●
P07.31	Previous 4 fault type			●
P07.32	Previous 5 fault type			●
P07.33	Running frequency at current fault		0.00Hz	●
P07.34	Ramp reference frequency at		0.00Hz	

Function code	Name	Detailed instruction of parameters	Default value	Modify
	current fault			
P07.35	Output voltage at the current fault		0V	
P07.36	Output current at current fault		0.0A	
P07.37	Bus voltage at current fault		0.0V	
P07.38	The Max. temperature at current fault		0.0°C	
P07.39	Input terminals state at current fault		0	●
P07.40	Output terminals state at current fault		0	●
P07.41	Running frequency at previous fault		0.00Hz	●
P07.42	Ramp reference frequency at previous fault		0.00Hz	●
P07.43	Output voltage at previous fault		0V	●
P07.44	The output current at previous fault		0.0A	●
P07.45	Bus voltage at previous fault		0.0V	●
P07.46	The Max. temperature at previous		0.0°C	●

Function code	Name	Detailed instruction of parameters	Default value	Modify
	fault			
P07.47	Input terminals state at previous fault		0	●
P07.48	Output terminals state at previous fault		0	●
P07.49	Runnig frequency at previous 2 fault		0.00Hz	●
P07.50	Output voltage at previous 2 faults		0.00Hz	●
P07.51	Output current at previous 2 faults		0V	●
P07.52	Output current at previous 2 fault		0.0A	●
P07.53	Bus voltage at previous 2 fault		0.0V	●
P07.54	The Max. temperature at previous 2 fault		0.0°C	●
P07.55	Input terminals state at previous 2 fault		0	●
P07.56	Output terminals state at previous 2		0	●

Function code	Name	Detailed instruction of parameters	Default value	Modify
	fault			
<b>P08 Group Enhanced function</b>				
P08.00	ACC time 2	Refer to P00.11 and P00.12 for detailed definition. MSi200A series define four groups of ACC/DEC time which can be selected by P5 group. The first group of ACC/DEC time is the factory default one. Setting range:0.0~3600.0s	Depend on model	<input type="radio"/>
P08.01	DEC time 2		Depend on model	<input type="radio"/>
P08.02	ACC time 3		Depend on model	<input type="radio"/>
P08.03	DEC time 3		Depend on model	<input type="radio"/>
P08.04	ACC time 4		Depend on model	<input type="radio"/>
P08.05	DEC time 4		Depend on model	<input type="radio"/>
P08.06	Jogging frequency	This parameter is used to define the reference frequency during jogging. Setting range: 0.00Hz ~P00.03 (the Max. frequency)	5.00Hz	<input type="radio"/>
P08.07	Jogging ACC time	The jogging ACC time means the time needed if the inverter runs from 0Hz to the Max. Frequency.	Depend on model	<input type="radio"/>
P08.08	Jogging DEC time	The jogging DEC time means the time needed if the inverter goes from the Max. Frequency (P0.03) to 0Hz. Setting range:0.0~3600.0s	Depend on model	<input type="radio"/>
P08.09	Jumping frequency 1	When the set frequency is in the range of jumping frequency, the inverter will run at the edge of the jumping frequency. The inverter can avoid the mechanical resonance point by setting the jumping frequency. The inverter can set three jumping frequency. But this function will be invalid if all jumping points are 0.	0.00Hz	<input type="radio"/>
P08.10	Jumping frequency range 1		0.00Hz	<input type="radio"/>
P08.11	Jumping frequency 2		0.00Hz	<input type="radio"/>
P08.12	Jumping frequency range 2		0.00Hz	<input type="radio"/>
P08.13	Jumping frequency 3		0.00Hz	<input type="radio"/>

Function code	Name	Detailed instruction of parameters	Default value	Modify
P08.14	Jumping frequency range 3	<p>Setting range: 0.00Hz ~P00.03 (the Max. frequency)</p>	0.00Hz	<input type="radio"/>
P08.15	Traverse range	This function applies to the industries where traverse and convolution function are required such as textile and chemical fiber.	0.0%	<input type="radio"/>
P08.16	Sudden jumping frequency range	The traverse function means that the output frequency of the inverter is fluctuated with the set frequency as its center. The route of the running frequency is illustrated as below, of which the traverse is set by P08.15 and when P08.15 is set as 0, the traverse is 0 with no function.	0.0%	<input type="radio"/>
P08.17	Traverse boost time		5.0s	<input type="radio"/>
P08.18	Traverse declining time	<p>Traverse range: The traverse running is limited by upper and low frequency.            The traverse range relative to the center frequency: <math>\text{traverse range AW} = \text{center frequency} \times \text{traverse range P08.15}</math>.            Sudden jumping frequency = <math>\text{traverse range AW} \times \text{sudden jumping frequency range P08.16}</math>.            When run at the traverse frequency, the value which is relative to the sudden jumping frequency.            The raising time of the traverse frequency: The time from the lowest point to the highest one.            The declining time of the traverse frequency: The time from the highest point to the lowest one.</p>	5.0s	<input type="radio"/>

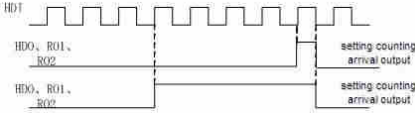
Function code	Name	Detailed instruction of parameters	Default value	Modify
		<p>The setting range of P08.15: 0.0~100.0% (relative to the set frequency)</p> <p>The setting range of P08.16: 0.0~50.0% (relative to the traverse range)</p> <p>The setting range of P08.17: 0.1~3600.0s</p> <p>The setting range of P08.18: 0.1~3600.0s</p>		
P08.19	Setting length	<p>The function codes of setting length, actual length and unit pulse are mainly used to control the fixed length.</p> <p>The length is counted by the pulse signal of HDI terminals input and the HDI terminals are needed to set as the length counting input.</p> <p>Actual length=the length counting input pulse /unit pulse</p> <p>When the actual length P08.20 exceeds the setting length P08.19, the multi-function digital output terminals will output ON.</p> <p>Setting range of P08.19: 0~65535m</p> <p>Setting range of P08.20:0~65535m</p> <p>Setting range of P08.21:1~10000</p> <p>Setting range of P08.22:0.01~100.00cm</p> <p>Setting range of P08.23:0.001~10.000</p> <p>Setting range of P08.24:0.001~1.000</p>	0m	<input type="radio"/>
P08.20	Actual length		0m	<input checked="" type="radio"/>
P08.21	Pulse per rotation		1	<input type="radio"/>
P08.22	Alxe perimeter		10.00 cm	<input type="radio"/>
P08.23	Length ratio		1.000	<input type="radio"/>
P08.24	Length correcting coefficient		1.000	<input type="radio"/>
P08.25	Setting counting value	<p>The counter works by the input pulse signals of the HDI terminals.</p> <p>When the counter achieves a fixed number, the multi-function output terminals will output the signal of "fixed counting number arrival" and the counter go on working; when the counter achieves a setting number, the multi-function output terminals will output the signal of "setting counting number arrival", the counter will clear all numbers and stop to recount before the next pulse.</p> <p>The setting counting value P08.26 should be no more than the setting counting value P08.25.</p> <p>The function is illustrated as below:</p>	0	<input type="radio"/>
P08.26	Reference counting value		0	<input type="radio"/>

Function code	Name	Detailed instruction of parameters	Default value	Modify
		Setting range of P08.25:P08.26~65535 Setting range of P08.26:0~P08.25		
P08.27	Set running time	Pre-set running time of the inverter. When the accumulative running time achieves the set time, the multi-function digital output terminals will output the signal of “running time arrival”. Setting range:0~65535 min	0m	<input type="radio"/>
P08.28	Fault reset times	The time of the fault reset: set the fault reset time by selecting this function. If the reset time exceeds this set value, the inverter will stop for the fault and wait to be repaired.	0	<input type="radio"/>
P08.29	Interval time of automatic fault reset	The interval time of the fault reset: The interval between the time when the fault occurs and the time when the reset action occurs. Setting range of P08.28:0~10 Setting range of P08.29:0.1~3600.0s	1.0s	<input type="radio"/>
P08.30	Frequency decreasing ratio of the dropping control	The output frequency of the inverter changes as the load. And it is mainly used to balance the power when several inverters drive one load. Setting range:0.00~10.00Hz	0.00Hz	<input type="radio"/>
P08.32	FDT1 electrical level detection value	When the output frequency exceeds the corresponding frequency of FDT electrical level, the multi-function digital output terminals will output the signal of “frequency level detect FDT” until the output frequency decreases to a value lower than (FDT electrical level—FDT retention detection value) the corresponding frequency, the signal is invalid. Below is the waveform diagram:	50.00 Hz	<input type="radio"/>
P08.33	FDT1 retention detection value	When the output frequency exceeds the corresponding frequency of FDT electrical level, the multi-function digital output terminals will output the signal of “frequency level detect FDT” until the output frequency decreases to a value lower than (FDT electrical level—FDT retention detection value) the corresponding frequency, the signal is invalid. Below is the waveform diagram:	5.0%	<input type="radio"/>
P08.34	FDT2 electrical level detection value		50.00 Hz	<input type="radio"/>
P08.35	FDT2 retention detection value		Setting range of P08.32: 0.00Hz~P00.03 (the Max. frequency) Setting range of P08.33: -100.0~100.0%	5.0%

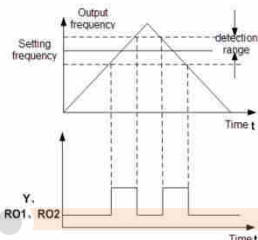
Function code	Name	Detailed instruction of parameters	Default value	Modify								
		(FDT1 electrical level) Setting range of P08.34: 0.00 Hz ~P00.03 (the Max. frequency) Setting range of P08.35: 0.0~100.0% (FDT2 electrical level)										
P08.36	Frequency arrival detection value	<p>When the output frequency is among the below or above range of the set frequency, the multi-function digital output terminal will output the signal of “frequency arrival”, see the diagram below for detailed information:</p>  <p>The setting range:0.00Hz~P00.03 (the Max. frequency)</p>	0.00Hz	<input type="radio"/>								
P08.37	Energy braking enable	<p>This parameter is used to control the internal braking unit.</p> <p>0:Disable 1:Enable</p> <p><b>Note:</b> Only applied to internal braking unit. After enabling, the overvoltage stall point will increase by 20V more than the energy braking point.</p>	0	<input type="radio"/>								
P08.38	Threshold voltage	<p>After setting the original bus voltage, adjust this parameter to break the load appropriately. The factory value changes with voltage level.</p> <p>The setting range:200.0~2000.0V</p> <p>In order to prevent customers set the value is too large, it is recommended setting range:</p>	380V voltage: 700.0V	<input type="radio"/>								
		<table border="1"> <tr> <td>voltage</td> <td>380V</td> <td>500V</td> <td>660</td> </tr> <tr> <td>range</td> <td>685~750V</td> <td>860~950V</td> <td>1080~1180V</td> </tr> </table>	voltage		380V	500V	660	range	685~750V	860~950V	1080~1180V	500V voltage: 900.0V
		voltage	380V		500V	660						
range	685~750V	860~950V	1080~1180V									
		660V voltage: 1120.0V										
P08.39	Cooling fan running mode	<p>Set the operation mode of the cooling fan.</p> <p>0: Normal mode, after the rectifier receives operation command or the detected temperature of module is above 45℃ or the module current is above 20% of the rated current, the fan rotates.</p>	0	<input type="radio"/>								



Function code	Name	Detailed instruction of parameters	Default value	Modify
		1:The fan keeps on running after power on (generally for the site with high temperature and humidity)		
P08.40	PWM selection	0x00~0x21 LED ones: PWM mode selection 0: PWM mode 1, three-phase modulation and two-modulation 1: PWM mode 2, three-phase modulation LED tens: low-speed carrier frequency limit mode 0: Low-speed carrier frequency limit mode 1, the carrier frequency will limit to 2k if it exceeds 2k at low speed 1:Low-speed carrier frequency limit mode 2, the carrier frequency will limit to 4k if it exceeds 4k at low speed 2: No limit	00	⊙
P08.41	Over commission selection	0x00~0x11 LED ones 0: Invalid 1: Valid LED tens 0: Light overcommission 1: Heavy overcommission	0x01	⊙
P08.42	Keypad data control	0x000~0x1223 LED ones:frequency enable selection 0:Both $\wedge/\vee$ keys and digital potentiometer adjustments are valid 1:Only $\wedge/\vee$ keys adjustment is valid 2:Only digital potentiometer adjustments is valid 3:Neither $\wedge/\vee$ keys nor digital potentiometer adjustments are valid LED tens: frequency control selection 0:Only valid when P00.06=0 or P00.07=0 1:Valid for all frequency setting manner 2:Invalid for multi-step speed when multi-step speed has the priority LED hundreds: action selection during stopping 0:Setting is valid 1:Valid during running, cleared after stopping 2:Valid during running, cleared after receiving the stop command LED thousands: $\wedge/\vee$ keys and digital	0x0000	○

Function code	Name	Detailed instruction of parameters	Default value	Modify
		potentiometer integral function 0:The integral function is valid 1:The integral function is invalid		
P08.43	Integral ratio of the keypad potentiometer	0.01~10.00s	0.10s	<input type="radio"/>
P08.44	UP/DOWN terminals control	0x00~0x221 LED ones: frequency control selection 0:UP/DOWN terminals setting valid 1:UP/DOWN terminals setting valid LED tens: frequency control selection 0:Only valid when P00.06=0 or P00.07=0 1:All frequency means are valid 2:When the multi-step are priority, it is invalid to the multi-step LED hundreds: action selection when stop 0:Setting valid 1: Valid in the running, clear after stop 2: Valid in the running, clear after receiving the stop commands	0x000	<input type="radio"/>
P08.45	UP terminals frequency increasing integral ratio	0.01~50.00Hz/s	0.50 Hz/s	<input type="radio"/>
P08.46	DOWN terminals frequency integral ratio	0.01~50.00 Hz/s	0.50 Hz/s	<input type="radio"/>
P08.47	Action when the frequency setting is off	0x000~0x111 LED ones: Action selection when power off. 0:Save when power off 1:Clear when power off LED tens: Action selection when MODBUS set frequency off 0:Save when power off 1:Clear when power off LED hundreds:The action selection when other frequency set frequency off 0:Save when power off 1:Clear when power off	0x000	<input type="radio"/>

Function code	Name	Detailed instruction of parameters	Default value	Modify
P08.48	High bit of initial power consumption	This parameter is used to set the original value of the power consumption. The original value of the power consumption = $P08.48 \times 1000 + P08.49$	0°	<input type="radio"/>
P08.49	Low bit of initial power consumption	Setting range of P08.48: 0~59999°(k) Setting range of P08.49:0.0~999.9°	0.0°	<input type="radio"/>
P08.50	Magnetic flux braking	This function code is used to enable magnetic flux. 0: Invalid. 100~150: The bigger the coefficient, the stronger the braking is. This inverter is used to increase the magnetic flux to decelerate the motor. The energy generated by the motor during braking can be converted into heat energy by increasing the magnetic flux. The inverter monitors the state of the motor continuously even during the magnetic flux period. So the magnetic flux can be used in the motor stop, as well as to change the rotation speed of the motor. Its other advantages are: Brake immediately after the stop command. It does not need to wait the magnetic flux weaken. Better cooling for motors. The current of the stator other than the rotor increases during magnetic flux braking, while the cooling of the stator is more effective than the rotor.	0	<input checked="" type="radio"/>
P08.51	Input power factor of the inverter	This function code is used to adjust the displayed current of the AC input side. Setting range:0.00~1.00	0.56	<input type="radio"/>
<b>P09 Group      PID control</b>				
P09.00	PID reference source	When the frequency command selection (P00.06, P00.07) is 7 or the voltage setting channel selection (P04.27) is 6, the running mode of the inverter is procedure PID controlled. The parameter determines the target reference channel during the PID process. 0:Keypad digital reference(P09.01) 1:Analog channel A1 reference (The inverter ( $\leq 15\text{kW}$ ) can be set by the analog potentiometer on the keypad and A1 setting is not available for the device which is $18.5\text{kW}$ or higher than $18.5\text{kW}$ )	0	<input type="radio"/>

Function code	Name	Detailed instruction of parameters	Default value	Modify
		2:Analog channel AI2 reference 3:Analog channel AI3 set 4:High speed pulse HDI set 5:Multi-step speed set 6:MODBUS communication set The setting target of procedure PID is a relative one, 100% of the setting equals to 100% of the response of the controlled system. The system is calculated according to the relative value (0~100.0%). <b>Note:</b> Multi-step speed reference, it is realized by setting P10 group parameters.		
P09.01	Keypad PID preset	When P09.00=0, set the parameter whose basic value is the feedback value of the system. The setting range:-100.0%~100.0%	0.0%	<input type="radio"/>
P09.02	PID feedback source	Select the PID channel by the parameter. 0:Analog channel AI1 feedback (The inverter( $\leq$ 15kW) can be set by the analog potentiometer on the keypad and AI1 setting is not available for the device which is 18.5kW or higher than 18.5 kW) 1:Analog channel AI2 feedback 2:Analog channel AI3 feedback 3:High speed HDI feedback 4:MODBUS communication feedback <b>Note:</b> The reference channel and the feedback channel can not coincide, otherwise, PID can not control effectively.	0	<input type="radio"/>
P09.03	PID output feature	0: PID output is positive: When the feedback signal exceeds the PID reference value, the output frequency of the inverter will decrease to balance the PID. For example, the strain PID control during wrap-up 1: PID output is negative: When the feedback signal is stronger than the PID reference value, the output frequency of the inverter will increase to balance the PID. For example, the strain PID control during wrap-down	0	<input type="radio"/>
P09.04	Proportional gain (Kp)	The function is applied to the proportional gain P of PID input. P determines the strength of the whole PID adjuster. The parameter of 100 means that when	1.00	<input type="radio"/>

Function code	Name	Detailed instruction of parameters	Default value	Modify
		the offset of PID feedback and reference value is 100%, the adjusting range of PID adjustor is the Max. Frequency (ignoring integral function and differential function). The setting range:0.00~100.00		
P09.05	Integral time(Ti)	This parameter determines the speed of PID adjustor to carry out integral adjustment on the deviation of PID feedback and reference. When the deviation of PID feedback and reference is 100%, the integral adjustor works continuously after the time (ignoring the proportional effect and differential effect) to achieve the Max. Frequency (P00.03) or the Max. Voltage (P04.31). Shorter the integral time, stronger is the adjustment Setting range: 0.01~10.00s	0.10s	<input type="radio"/>
P09.06	Differential time(Td)	This parameter determines the strength of the change ratio when PID adjustor carries out integral adjustment on the deviation of PID feedback and reference. If the PID feedback changes 100% during the time, the adjustment of integral adjustor (ignoring the proportional effect and differential effect) is the Max. Frequency (P00.03) or the Max. Voltage (P04.31). Longer the integral time, stronger is the adjusting. Setting range: 0.00~10.00s	0.00s	<input type="radio"/>
P09.07	Sampling cycle(T)	This parameter means the sampling cycle of the feedback. The modulator calculates in each sampling cycle. The longer the sapling cycle is, the slower the response is. Setting range: 0.000~10.000s	0.100s	<input type="radio"/>
P09.08	PID control deviation limit	The output of PID system is relative to the maximum deviation of the close loop reference. As shown in the diagram below, PID adjustor stops to work during the deviation limit. Set the function properly to adjust the accuracy and stability of the system.	0.0%	<input type="radio"/>

Function code	Name	Detailed instruction of parameters	Default value	Modify
		<p>Setting range:0.0~100.0%</p>		
P09.09	Output upper limit of PID	These parameters are used to set the upper and lower limit of the PID adjustor output. 100.0 % corresponds to Max. frequency or the Max. voltage of ( P04.31)	100.0%	<input type="radio"/>
P09.10	Output lower limit of PID	Setting range of P09.09: P09.10~100.0% Setting range of P09.10: -100.0%~P09.09	0.0%	<input type="radio"/>
P09.11	Feedback offline detection value	Set the PID feedback offline detection value, when the detection value is smaller than or equal to the feedback offline detection value, and the lasting time exceeds the set value in P09.12, the inverter will report "PID feedback offline fault" and the keypad will display PIDE.	0.0%	<input type="radio"/>
P09.12	Feedback offline detection time	<p>Setting range of P09.11: 0.0~100.0% Setting range of P09.12: 0.0~3600.0s</p>	1.0s	<input type="radio"/>
P09.13	PID adjustment	0x0000~0x1111 LED ones: 0: Keep on integral adjustment when the frequency achieves the upper and low limit; the integration shows the change between the reference and the feedback unless it reaches the internal integral limit. When the trend between the reference and the feedback changes, it needs more time to offset the impact of continuous working and the integration will change with the trend. 1: Stop integral adjustment when the frequency	0x0001	<input type="radio"/>

Function code	Name	Detailed instruction of parameters	Default value	Modify
		<p>achieves the upper and low limit. If the integration keeps stable, and the trend between the reference and the feedback changes, the integration will change with the trend quickly.</p> <p>LED tens: P00.08 is 0</p> <p>0: The same with the setting direction; if the output of PID adjustment is different from the current running direction, the internal will output 0 forcedly.</p> <p>1: Opposite to the setting direction</p> <p>LED hundreds: P00.08 is 0</p> <p>0: Limit to the maximum frequency</p> <p>1: Limit to frequency A</p> <p>LED thousands:</p> <p>0: A+B frequency, the buffer of A frequency is invalid</p> <p>1: A+B frequency, the buffer of A frequency is valid</p> <p>ACC/DEC is determined by ACC time 4 of P08.04</p>		
P09.14	Proportional gain at low frequency (Kp)	0.00~100.00	1.00	○
P09.15	PID command of ACC/DEC time	0.0~1000.0s	0.0s	○
P09.16	PID output filter time	0.000~10.000s	0.000s	○
<b>P10 Group Simple PLC and multi-step speed control</b>				
P10.00	Simple PLC	<p>0: Stop after running once. The inverter has to be commanded again after finishing a cycle.</p> <p>1: Run at the final value after running once. After finish a signal, the inverter will keep the running frequency and direction of the last run.</p> <p>2: Cycle running. The inverter will keep on running until receiving a stop command and then, the system will stop.</p>	0	○
P10.01	Simple PLC	0: Power loss without memory	0	○

Function code	Name	Detailed instruction of parameters	Default value	Modify
	memory	1:Power loss memory: PLC record the running step and frequency when power loss.		
P10.02	Multi-step speed 0	100.0% of the frequency setting corresponds to the Max. frequency P00.03.	0.0%	○
P10.03	The running time of step 0	When selecting simple PLC running, set P10.02~P10.33 to define the running frequency and direction of all steps.	0.0s	○
P10.04	Multi-step speed 1	<b>Note:</b> The symbol of multi-step determines the running direction of simple PLC. The negative value means reverse rotation.	0.0%	○
P10.05	The running time of step 1		0.0s	○
P10.06	Multi-step speed 2		0.0%	○
P10.07	The running time of step 2		0.0s	○
P10.08	Multi-step speed 3		0.0%	○
P10.09	The running time of step 3	Multi-step speeds are in the range of $-f_{max} \sim f_{max}$ and it can be set continuously.	0.0s	○
P10.10	Multi-step speed 4	MSI200A series inverters can set 16 steps speed, selected by the combination of multi-step terminals 1~4, corresponding to the speed 0 to speed 15.	0.0%	○
P10.11	The running time of step 4		0.0s	○
P10.12	Multi-step speed 5		0.0%	○
P10.13	The running time of step 5		0.0s	○
P10.14	Multi-step speed 6		0.0%	○
P10.15	The running time of step 6		0.0s	○
P10.16	Multi-step speed 7		0.0%	○
P10.17	The running time of step 7		0.0s	○
P10.18	Multi-step speed 8	When S1=S2=S3=S4=OFF, the frequency input manner is selected via code P00.06 or P00.07.	0.0%	○
P10.19	The running time of step 8	When all S1=S2=S3=S4 terminals aren't off, it runs at multi-step which takes precedence of keypad, analog value, high-speed pulse, PLC, communication frequency input. Select at most 16 steps speed via the combination code of S1,	0.0s	○
P10.20	Multi-step speed 9		0.0%	○

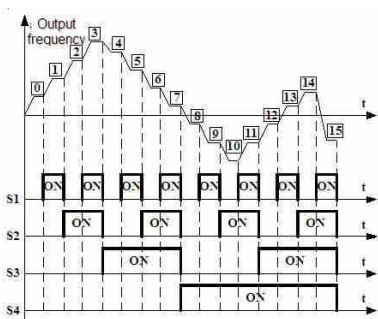
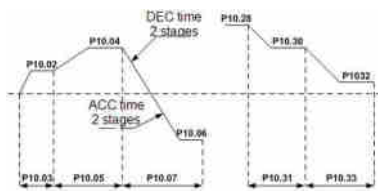



Function code	Name	Detailed instruction of parameters	Default value	Modify																																
P10.21	The running time of step 9	S2, S3, and S4.	0.0s	<input type="radio"/>																																
P10.22	Multi-step speed 10	The start-up and stopping of multi-step running is determined by function code P00.06, the relationship between S1,S2,S3,S4 terminals and multi-step speed is as following:	0.0%	<input type="radio"/>																																
P10.23	The running time of step 10	<table border="1"> <tr><td>S1</td><td>OFF</td><td>ON</td><td>OFF</td><td>ON</td><td>OFF</td><td>ON</td><td>OFF</td><td>ON</td></tr> <tr><td>S2</td><td>OFF</td><td>OFF</td><td>ON</td><td>ON</td><td>OFF</td><td>OFF</td><td>ON</td><td>ON</td></tr> </table>	S1	OFF	ON	OFF	ON	OFF	ON	OFF	ON	S2	OFF	OFF	ON	ON	OFF	OFF	ON	ON	0.0s	<input type="radio"/>														
S1	OFF	ON	OFF	ON	OFF	ON	OFF	ON																												
S2	OFF	OFF	ON	ON	OFF	OFF	ON	ON																												
P10.24	Multi-step speed 11	<table border="1"> <tr><td>S3</td><td>OFF</td><td>OFF</td><td>OFF</td><td>OFF</td><td>ON</td><td>ON</td><td>ON</td><td>ON</td></tr> <tr><td>S4</td><td>OFF</td><td>OFF</td><td>OFF</td><td>OFF</td><td>OFF</td><td>OFF</td><td>OFF</td><td>OFF</td></tr> </table>	S3	OFF	OFF	OFF	OFF	ON	ON	ON	ON	S4	OFF	OFF	OFF	OFF	OFF	OFF	OFF	OFF	0.0%	<input type="radio"/>														
S3	OFF	OFF	OFF	OFF	ON	ON	ON	ON																												
S4	OFF	OFF	OFF	OFF	OFF	OFF	OFF	OFF																												
P10.25	The running time of step 11	<table border="1"> <tr><td>Step</td><td>0</td><td>1</td><td>2</td><td>3</td><td>4</td><td>5</td><td>6</td><td>7</td></tr> <tr><td>S1</td><td>OFF</td><td>ON</td><td>OFF</td><td>ON</td><td>OFF</td><td>ON</td><td>OFF</td><td>ON</td></tr> <tr><td>S2</td><td>OFF</td><td>OFF</td><td>ON</td><td>ON</td><td>OFF</td><td>OFF</td><td>ON</td><td>ON</td></tr> </table>	Step	0	1	2	3	4	5	6	7	S1	OFF	ON	OFF	ON	OFF	ON	OFF	ON	S2	OFF	OFF	ON	ON	OFF	OFF	ON	ON	0.0s	<input type="radio"/>					
Step	0	1	2	3	4	5	6	7																												
S1	OFF	ON	OFF	ON	OFF	ON	OFF	ON																												
S2	OFF	OFF	ON	ON	OFF	OFF	ON	ON																												
P10.26	Multi-step speed 12	<table border="1"> <tr><td>S3</td><td>OFF</td><td>OFF</td><td>OFF</td><td>OFF</td><td>ON</td><td>ON</td><td>ON</td><td>ON</td></tr> <tr><td>S4</td><td>ON</td><td>ON</td><td>ON</td><td>ON</td><td>ON</td><td>ON</td><td>ON</td><td>ON</td></tr> </table>	S3	OFF	OFF	OFF	OFF	ON	ON	ON	ON	S4	ON	ON	ON	ON	ON	ON	ON	ON	0.0%	<input type="radio"/>														
S3	OFF	OFF	OFF	OFF	ON	ON	ON	ON																												
S4	ON	ON	ON	ON	ON	ON	ON	ON																												
P10.27	The running time of step 12	<table border="1"> <tr><td>Step</td><td>8</td><td>9</td><td>10</td><td>11</td><td>12</td><td>13</td><td>14</td><td>15</td></tr> </table>	Step	8	9	10	11	12	13	14	15	0.0s	<input type="radio"/>																							
Step	8	9	10	11	12	13	14	15																												
P10.28	Multi-step speed 13	Setting range of P10.(2n,1<n<17): -100.0~100.0%	0.0%	<input type="radio"/>																																
P10.29	The running time of step 13	Setting range of P10.(2n+1,1<n<17):0.0~6553.5s(min)	0.0s	<input type="radio"/>																																
P10.30	Multi-step speed 14		0.0%	<input type="radio"/>																																
P10.31	The running time of step 14		0.0s	<input type="radio"/>																																
P10.32	Multi-step speed 15		0.0%	<input type="radio"/>																																
P10.33	The running time of step 15		0.0s	<input type="radio"/>																																
P10.34	Simple PLC 0~7 step ACC/DEC time	Below is the detailed instruction:	0x0000	<input type="radio"/>																																
P10.35	Simple PLC 8~15 step ACC/DEC time	<table border="1"> <thead> <tr> <th>Function code</th> <th>Binary bit</th> <th>Step</th> <th>ACC/DE C 0</th> <th>ACC/DE C 1</th> <th>ACC/DE C 2</th> <th>ACC/DE C 3</th> </tr> </thead> <tbody> <tr> <td rowspan="4">P10.34</td> <td>BIT1 BIT0</td> <td>0</td> <td>00</td> <td>01</td> <td>10</td> <td>11</td> </tr> <tr> <td>BIT3 BIT2</td> <td>1</td> <td>00</td> <td>01</td> <td>10</td> <td>11</td> </tr> <tr> <td>BIT5 BIT4</td> <td>2</td> <td>00</td> <td>01</td> <td>10</td> <td>11</td> </tr> <tr> <td>BIT7 BIT6</td> <td>3</td> <td>00</td> <td>01</td> <td>10</td> <td>11</td> </tr> </tbody> </table>	Function code	Binary bit	Step	ACC/DE C 0	ACC/DE C 1	ACC/DE C 2	ACC/DE C 3	P10.34	BIT1 BIT0	0	00	01	10	11	BIT3 BIT2	1	00	01	10	11	BIT5 BIT4	2	00	01	10	11	BIT7 BIT6	3	00	01	10	11	0x0000	<input type="radio"/>
Function code	Binary bit	Step	ACC/DE C 0	ACC/DE C 1	ACC/DE C 2	ACC/DE C 3																														
P10.34	BIT1 BIT0	0	00	01	10	11																														
	BIT3 BIT2	1	00	01	10	11																														
	BIT5 BIT4	2	00	01	10	11																														
	BIT7 BIT6	3	00	01	10	11																														

Function code	Name	Detailed instruction of parameters	Default value	Modify																																																																																				
		<table border="1"> <tr> <td>BIT9</td> <td>BIT8</td> <td>4</td> <td>00</td> <td>01</td> <td>10</td> <td>11</td> </tr> <tr> <td>BIT11</td> <td>BIT10</td> <td>5</td> <td>00</td> <td>01</td> <td>10</td> <td>11</td> </tr> <tr> <td>BIT13</td> <td>BIT12</td> <td>6</td> <td>00</td> <td>01</td> <td>10</td> <td>11</td> </tr> <tr> <td>BIT15</td> <td>BIT14</td> <td>7</td> <td>00</td> <td>01</td> <td>10</td> <td>11</td> </tr> </table> <table border="1"> <tr> <td>BIT1</td> <td>BIT0</td> <td>8</td> <td>00</td> <td>01</td> <td>10</td> <td>11</td> </tr> <tr> <td>BIT3</td> <td>BIT2</td> <td>9</td> <td>00</td> <td>01</td> <td>10</td> <td>11</td> </tr> <tr> <td>BIT5</td> <td>BIT4</td> <td>10</td> <td>00</td> <td>01</td> <td>10</td> <td>11</td> </tr> <tr> <td>BIT7</td> <td>BIT6</td> <td>11</td> <td>00</td> <td>01</td> <td>10</td> <td>11</td> </tr> <tr> <td>BIT9</td> <td>BIT8</td> <td>12</td> <td>00</td> <td>01</td> <td>10</td> <td>11</td> </tr> <tr> <td>BIT11</td> <td>BIT10</td> <td>13</td> <td>00</td> <td>01</td> <td>10</td> <td>11</td> </tr> <tr> <td>BIT13</td> <td>BIT12</td> <td>14</td> <td>00</td> <td>01</td> <td>10</td> <td>11</td> </tr> <tr> <td>BIT15</td> <td>BIT14</td> <td>15</td> <td>00</td> <td>01</td> <td>10</td> <td>11</td> </tr> </table> <p>P10.35</p> <p>After the users select the corresponding ACC/DEC time, the combined 16 binary bits will change into decimal bit, and then set the corresponding function codes. Setting range: 0x0000~0xFFFF</p>	BIT9	BIT8	4	00	01	10	11	BIT11	BIT10	5	00	01	10	11	BIT13	BIT12	6	00	01	10	11	BIT15	BIT14	7	00	01	10	11	BIT1	BIT0	8	00	01	10	11	BIT3	BIT2	9	00	01	10	11	BIT5	BIT4	10	00	01	10	11	BIT7	BIT6	11	00	01	10	11	BIT9	BIT8	12	00	01	10	11	BIT11	BIT10	13	00	01	10	11	BIT13	BIT12	14	00	01	10	11	BIT15	BIT14	15	00	01	10	11		
BIT9	BIT8	4	00	01	10	11																																																																																		
BIT11	BIT10	5	00	01	10	11																																																																																		
BIT13	BIT12	6	00	01	10	11																																																																																		
BIT15	BIT14	7	00	01	10	11																																																																																		
BIT1	BIT0	8	00	01	10	11																																																																																		
BIT3	BIT2	9	00	01	10	11																																																																																		
BIT5	BIT4	10	00	01	10	11																																																																																		
BIT7	BIT6	11	00	01	10	11																																																																																		
BIT9	BIT8	12	00	01	10	11																																																																																		
BIT11	BIT10	13	00	01	10	11																																																																																		
BIT13	BIT12	14	00	01	10	11																																																																																		
BIT15	BIT14	15	00	01	10	11																																																																																		
P10.36	PLC restart	<p>0: Restart from the first step; stop during running (cause by the stop command, fault or power loss), run from the first step after restart.</p> <p>1: Continue to run from the stop frequency; stop during running(cause by stop command and fault), the inverter will record the running time automatically, enter into the step after restart and keep the remaining running at the setting frequency.</p>	0	⊙																																																																																				
P10.37	Multi-step time unit	<p>0: Seconds; the running time of all steps is counted by second</p> <p>1: Minutes; the running time of all steps is counted by minute</p>	0	⊙																																																																																				
<b>P11 Group Protective parameters</b>																																																																																								
P11.00	Phase loss protection	<p>0x00~0x11</p> <p>LED ones:</p> <p>0: Input phase loss protection disable</p> <p>1: Input phase loss protection enable</p> <p>LED tens:</p> <p>0: Input phase loss protection disable</p>	111	○																																																																																				

Function code	Name	Detailed instruction of parameters	Default value	Modify								
		1: Input phase loss protection enable LED hundreds: 0: Input phase loss hardware protection disable 1: Input phase loss hardware protection enable										
P11.01	Sudden power loss frequency-decreasing	0: Enable 1: Disable	0	<input type="radio"/>								
P11.02	Frequency decreasing ratio of sudden power loss	<p>Setting range: 0.00Hz/s~P00.03 (the Max. frequency) After the power loss of the grid, the bus voltage drops to the sudden frequency-decreasing point, the inverter begin to decrease the running frequency at P11.02, to make the inverter generate power again. The returning power can maintain the bus voltage to ensure a rated running of the inverter until the recovery of power.</p> <table border="1"> <thead> <tr> <th>Voltage degree</th> <th>220V</th> <th>380V</th> <th>660V</th> </tr> </thead> <tbody> <tr> <td>Frequency-decreasing point at sudden power loss</td> <td>260V</td> <td>460V</td> <td>800V</td> </tr> </tbody> </table> <p><b>Note:</b> 1. Adjust the parameter properly to avoid the stopping caused by inverter protection during the switching of the grid. 2. Prohibition of input phase protection can enable this function.</p>	Voltage degree	220V	380V	660V	Frequency-decreasing point at sudden power loss	260V	460V	800V	10.00 Hz/s	<input type="radio"/>
Voltage degree	220V	380V	660V									
Frequency-decreasing point at sudden power loss	260V	460V	800V									
P11.03	Overvoltage stall protection	0:Disable 1:Enable  	1	<input type="radio"/>								
P11.04	Protection voltage at overvoltage stall	120~150%(standard bus voltage) (380V)	140%	<input type="radio"/>								
		120~150%(standard bus voltage) (220V)	120%									

Function code	Name	Detailed instruction of parameters	Default value	Modify
P11.05	Current limit action selection	<p>The actual increasing ratio is less than the ratio of output frequency because of the big load during ACC running. It is necessary to take measures to avoid overcurrent fault and the inverter trips.</p> <p>During the running of the inverter, this function will detect the output current and compare it with the limit defined in P11.06. If it exceeds the level, the inverter will run at stable frequency in ACC running, or the inverter will derate to run during the constant running. If it exceeds the level continuously, the output frequency will keep on decreasing to the lower limit. If the output current is detected to be lower than the limit level, the inverter will accelerate to run.</p>	01	☉
P11.06	Automatic current limit		G: 160.0% P: 120.0%	☉
P11.07	The decreasing ratio during current limit		<p>Setting range of P11.05: 0x00~0x11 LED ones:current limit 0:Invalid 1:Always invalid LED tens:overload alarm 0:Valid 1: Invalid Setting range of P11.06: 50.0~200.0% Setting range of P11.07: 0.00~50.00Hz/s</p>	10.00 Hz/s
P11.08	Overload pre-alarm of the motor/inverter	<p>The output current of the inverter or the motor is above P11.09 and the lasting time is beyond P11.10, overload pre-alarm will be output.</p>	0x000	○
P11.09	Overload pre-alarm test level		G: 150% P: 120%	○
P11.10	Overload pre-alarm detection		1.0s	○

Function code	Name	Detailed instruction of parameters	Default value	Modify
	time	Setting range of P11.08: Enable and define the overload pre-alarm of the inverter or the motor. Setting range: 0x000~0x131 LED ones: 0:Overload pre-alarm of the motor, comply with the rated current of the motor 1:Overload pre-alarm of the inverter, comply with the rated current of the inverter LED tens: 0:The inverter continues to work after underload pre-alarm 1:The inverter continues to work after underload pre-alarm and the inverter stops running after overload fault 2: The inverter continues to work after overload pre-alarm and the inverter stops running after underload fault 3. The inverter stops when overloading or underloading. LED hundreds : 0:Detection all the time 1:Detection in constant running Setting range of P11.09: P11.11~200% Setting range of P11.10: 0.1~3600.0s		
P11.11	Detection level of the underload pre-alarm	If the inverter current or the output current is lower than P11.11, and its lasting time is beyond P11.12, the inverter will output underload pre-alarm.	50%	<input type="radio"/>
P11.12	Detection time of the underload pre-alarm	Setting range of P11.11: 0~P11.09 Setting range of P11.12: 0.1~3600.0s	1.0s	<input type="radio"/>
P11.13	Output terminal action during fault	Select the action of fault output terminals on undervoltage and fault reset. 0x00~0x11 LED ones: 0:Action under fault undervoltage 1:No action under fault undervoltage LED tens: 0:Action during the automatic reset 1:No action during the automatic reset	0x00	<input type="radio"/>

Function code	Name	Detailed instruction of parameters	Default value	Modify
P11.16	Extension functions selection	0x00~0x11 LED ones: Voltage drop frequency-decreasing selection 0: Voltage drop frequency-decreasing selection disable 1: Voltage drop frequency-decreasing selection enable LED tens: Step 2 ACC/DEC time option 0: Step 2 ACC/DEC time option disable 1: Step 2 ACC/DEC time option enable , when running frequency more than P08.36, ACC/DEC time switch to step 2 ACC/DEC time	00	<input type="radio"/>
<b>P13 Group Reserved</b>				
P13.13	Braking current of short-circuit	When P01.00=0 during the starting of the inverter, set P13.14 to a non-zero value to enter the short circuit braking.	0.0%	<input type="radio"/>
P13.14	Braking retention time before starting	When the running frequency is lower than P01.09 during the stopping of the inverter, set 13.15 to a non-zero value to enter into stopping short circuited braking and then carry out the DC braking at the time set by P01.12 (refer to the instruction of P01.09~P01.12) .	0.00s	<input type="radio"/>
P13.15	The braking retention time when stopping	Setting range of P13.13: 0.0~150.0% (the inverter) Setting range of P13.14: 0.00~50.00s Setting range of P13.15: 0.00~50.00s	0.00s	<input type="radio"/>
<b>P14 Group Serial communication</b>				
P14.00	Local communication address	The setting range: 1~247 When the master is writing the frame, the communication address of the slave is set to 0; the broadcast address is the communication address. All slaves on the MODBUS fieldbus can receive the frame, but the slave doesn't answer. The communication address of the drive is unique in the communication net. This is the fundamental for the point to point communication between the upper monitor and the drive. <b>Note:</b> The address of the slave cannot set to 0.	1	<input type="radio"/>
P14.01	Communication baud ratio	Set the digital transmission speed between the upper monitor and the inverter. 0: 1200BPS 1: 2400BPS	4	<input type="radio"/>

Function code	Name	Detailed instruction of parameters	Default value	Modify
		2:4800BPS 3:9600BPS 4:19200BPS 5:38400BPS 6:57600BPS 7:115200BPS <b>Note:</b> The baud rate between the upper monitor and the inverter must be the same. Otherwise, the communication is not applied. The bigger the baud rate, the quicker the communication speed.		
P14.02	Digital bit checkout	The data format between the upper monitor and the inverter must be the same. Otherwise, the communication is not applied. 0: No check (N,8,1) for RTU 1: Even check (E,8,1) for RTU 2: Odd check (O,8,1) for RTU 3:No check (N,8,2) for RTU 4: Even check (E,8,2) for RTU 5: Odd check(O,8,2) for RTU 6: No check (N,7,1) for ASCII 7: Even check (E,7,1) for ASCII 8: Odd check (O,7,1) for ASCII 9:No check (N,7,2) for ASCII 10: Even check (E,7,2) for ASCII 11: Odd check(O,7,2) for ASCII 12: No check (N,8,1) for ASCII 13: Even check (E,8,1) for ASCII 14: Odd check (O,8,1) for ASCII 15:No check (N,8,2) for ASCII 16: Even check (E,8,2) for ASCII 17: Odd check(O,8,2) for ASCII	1	<input type="radio"/>
P14.03	Answer delay	0~200ms It means the interval time between the interval time when the drive receive the data and sent it to the upper monitor. If the answer delay is shorter than the system processing time, then the answer delay time is the system processing time, if the answer delay is longer than the system processing time, then after the system deal with the data, waits until achieving the answer delay time to send the data to the upper monitor.	5	<input type="radio"/>

Function code	Name	Detailed instruction of parameters	Default value	Modify
P14.04	Fault time of communication overtime	<p>0.0(invalid), 0.1~60.0s</p> <p>When the function code is set as 0.0, the communication overtime parameter is invalid.</p> <p>When the function code is set as non-zero, if the interval time between two communications exceeds the communication overtime, the system will report "485 communication faults" (CE).</p> <p>Generally, set it as invalid; set the parameter in the continuous communication to monitor the communication state.</p>	0.0s	<input type="radio"/>
P14.05	Transmission fault processing	<p>0:Alarm and stop freely</p> <p>1:No alarm and continue to run</p> <p>2:No alarm and stop according to the stop means (only under the communication control)</p> <p>3:No alarm and stop according to the stop means (under all control modes)</p>	0	<input type="radio"/>
P14.06	Communication processing	<p>LED ones:</p> <p>0: Operation with response: the drive will respond to all reading and writing commands of the upper monitor.</p> <p>1:Operation without response: The drive only responds to the reading command other than the writing command of the drive. The communication efficiency can be increased by this method.</p> <p>LED tens:</p> <p>0: Communication encrypting valid</p> <p>1: Communication encrypting invalid</p>	0x00	<input type="radio"/>
<b>P16 Group Ethernet function</b>				
<b>P17 Group Monitoring function</b>				
P17.00	Setting frequency	Display current set frequency of the inverter Range: 0.00Hz~P00.03		●
P17.01	Output frequency	Display current output frequency of the inverter Range: 0.00Hz~P00.03		●
P17.02	Ramp reference frequency	Display current ramp reference frequency of the inverter Range: 0.00Hz~P00.03		●
P17.03	Output voltage	Display current output voltage of the inverter Range: 0~1200V		●



Function code	Name	Detailed instruction of parameters	Default value	Modify																				
P17.04	Output current	Display current output current of the inverter Range: 0.0~3000.0A		●																				
P17.05	Motor speed	Display the rotation speed of the motor. Range: 0~65535RPM		●																				
P17.08	Motor power	Display current motor power Range:-300~300%		●																				
P17.09	Output torque	Display the current output torque of the inverter. Range: -250.0~250.0%		●																				
P17.10	Evaluated motor frequency	Evaluated frequency of motor rotor Range: 0.00Hz~ P00.03		●																				
P17.11	DC bus voltage	Display current DC bus voltage of the inverter Range: 0.0~2000.0V		●																				
P17.12	ON-OFF input terminals state	Display current Switch input terminals state of the inverter <table border="1" style="margin-left: auto; margin-right: auto;"> <tr> <td></td> <td>BIT8</td> <td>BIT7</td> <td>BIT6</td> <td>BIT5</td> </tr> <tr> <td></td> <td>HDI</td> <td>S8</td> <td>S7</td> <td>S6</td> </tr> <tr> <td>BIT4</td> <td>BIT3</td> <td>BIT2</td> <td>BIT1</td> <td>BIT0</td> </tr> <tr> <td>S5</td> <td>S4</td> <td>S3</td> <td>S2</td> <td>S1</td> </tr> </table> Range: 0000~00FF		BIT8	BIT7	BIT6	BIT5		HDI	S8	S7	S6	BIT4	BIT3	BIT2	BIT1	BIT0	S5	S4	S3	S2	S1		●
	BIT8	BIT7	BIT6	BIT5																				
	HDI	S8	S7	S6																				
BIT4	BIT3	BIT2	BIT1	BIT0																				
S5	S4	S3	S2	S1																				
P17.13	ON-OFF output terminals state	Display current Switch output terminals state of the inverter <table border="1" style="margin-left: auto; margin-right: auto;"> <tr> <td>BIT3</td> <td>BIT2</td> <td>BIT1</td> <td>BIT0</td> </tr> <tr> <td>RO2</td> <td>RO1</td> <td>HDO</td> <td>Y</td> </tr> </table> Range: 0000~000F	BIT3	BIT2	BIT1	BIT0	RO2	RO1	HDO	Y		●												
BIT3	BIT2	BIT1	BIT0																					
RO2	RO1	HDO	Y																					
P17.14	Digital adjustment	Display the adjustment through the keypad of the inverter. Range : 0.00Hz~P00.03		●																				
P17.15	torque reference	Display the torque given, the percentage to the current rated torque of the motor. Setting range: -300.0%~300.0% (the rated current of the motor)		●																				
P17.16	Linear speed	Display the current linear speed of the inverter. Range: 0~65535		●																				
P17.17	Length	Display the current length of the inverter. Range: 0~65535		●																				
P17.18	Counting value	Display the current counting number of the inverter. Range: 0~65535		●																				
P17.19	A11 input voltage	The inverter( $\leq 15\text{kW}$ ) can be set by the analog potentiometer on the keypad and A11 setting is		●																				

Function code	Name	Detailed instruction of parameters	Default value	Modify
		not available for the device which is 18.5kW or higher than 18.5 kW. Display analog AI1 input signal Range: 0.00~10.00V		
P17.20	AI2 input voltage	Display analog AI2 input signal Range: 0.00~10.00V		●
P17.21	AI3 input voltage	Display analog AI2 input signal Range: -10.00~10.00V		●
P17.22	HDI input frequency	Display HDI input frequency Range: 0.000~50.000kHz		●
P17.23	PID reference value	Display PID reference value Range: -100.0~100.0%		●
P17.24	PID feedback value	Display PID response value Range: -100.0~100.0%		●
P17.25	Power factor of the motor	Display the current power factor of the motor. Range: -1.00~1.00		●
P17.26	Current running time	Display the current running time of the inverter. Range:0~65535min		●
P17.27	Simple PLC and the current step of the multi-step speed	Display simple PLC and the current step of the multi-step speed Range: 0~15		●
P17.35	AC input current	Display the input current in AC side. Range: 0.0~5000.0A		●
P17.36	Output torque	Display the output torque. Positive value is in the electromotion state, and negative is in the power generating state. Range : -3000.0Nm~3000.0Nm		●
P17.37	Counting of the motor overload	0~100 (100 is OL1 fault)		●
P17.38	PID output	-100.00~100.00%	0.00%	●
P17.39	Wrong download of parameters	0.00~99.99	0.00	●
<b>P24 Group Water supply</b>				
P24.00	Water supply	0: Disabled 1: Enabled	0	◎

Function code	Name	Detailed instruction of parameters	Default value	Modify
	selection			
P24.01	Press feedback source	0: AI1 setting value (The inverter( $\leq 15\text{kW}$ ) can be set by the analog potentiometer on the keypad and AI1 setting is not available for the device which is 18.5kW or higher than 18.5 kW) 1: AI2 setting value 2: AI3 setting value 3: HDI setting value	0	○
P24.02	Hibernation check	0: Hibernate as the setting frequency < P24.03 1: Hibernate as the feedback pressure > P24.04	0	◎
P24.03	Starting frequency of the hibernation	0.00~P0.03(the Max. frequency)	10.00 Hz	○
P24.04	Starting pressure of hibernation	0.00~100.0%	50.0%	○
P24.05	Hibernation delay time	0.0~3600.0s	5.0s	○
P24.06	Hibernation awake	0: Awake as the setting frequency > P24.07 1: Awake as the feedback pressure < P24.08	0	◎
P24.07	Awake frequency	0.00~P0.03(the Max. frequency)	20.00 Hz	○
P24.08	Setting value of hibernation awake	0.00~100.0%	10.0%	○
P24.09	Mini hibernation time	0.0~3600.0s	5.0s	○
P24.10	Valid auxiliary motor	P24.10~P24.12 can make three motors to form a simple system of water supply.	0	○
P24.11	Start/stop delay time of auxiliary motor 1	<pre> graph TD     Start([Output frequency of the motor]) --&gt; D1{Is the upper frequency?}     D1 -- N --&gt; S1[Start any motor start begin delay counting]     D1 -- Y --&gt; D2{Is the lower frequency?}     D2 -- N --&gt; End([End])     D2 -- Y --&gt; S2[Auxiliary motor stop begin delay counting]     S2 --&gt; D3{Reach the stop delay time}     D3 -- Y --&gt; S3[Stop the auxiliary motor 1 and 2]     D3 -- N --&gt; End     S1 --&gt; D4{Reach the start delay time}     D4 -- Y --&gt; S4[Start the auxiliary motor 1 and 2]     D4 -- N --&gt; End     </pre>	5.0s	○
P24.12	Start/stop delay time of auxiliary motor 2		5.0s	○

P24.10 is used to select the valid auxiliary motor.

Function code	Name	Detailed instruction of parameters	Default value	Modify
		0: No auxiliary motor 1: Auxiliary motor 1 valid 2: Auxiliary motor 2 valid 3: Auxiliary motor 1 and 2 valid Setting range of P24.10: 0.0~3600.0s Setting range of P24.11: 0.0~3600.0s		

 KEILRIEMEN.AT

## 7 Basic Operation Instruction

---

### 7.1 What this chapter contains

This chapter describes the internal function mode of the inverter in details.



- ✧ Check all terminals are connected properly and tightly.
- ✧ Check that the power of the motor corresponds to that of the inverter.

### 7.2 First powering on

#### Check before powering on

Please check according to the installation list in chapter two.

#### Original powering operation

Check to ensure there is no mistake in wiring and power supply, switch on the air switch of the AC power supply on the input side of the inverter to power on the inverter. 8.8.8.8. will be displayed on the keypad, and the contactor closes normally. When the character on the nixie tube changes to the set frequency, the inverter has finished the initialization and it is in the stand-by state.

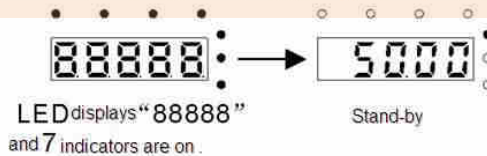

Below diagram shows the first operation: (take motor 1 as the example)

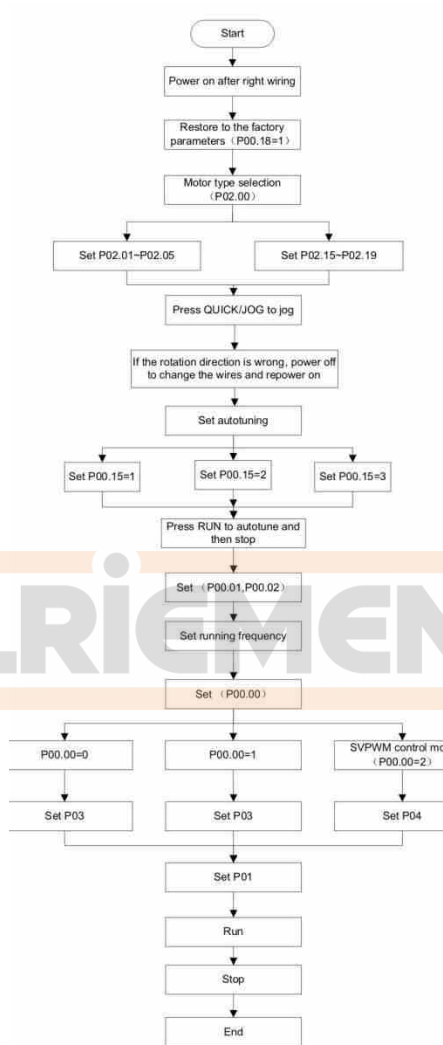

**Note:** If fault occurs, please do as the “Fault Tracking”. Estimate the fault reason and settle the issue.

Besides P00.01 and P00.02, terminal command setting can also be used to set the running command channel.

Current running command channel P00.01	Multi-function terminal 36 Shifting the command to keypad	Multi-function terminal 37 Shifting the command to communication	Multi-function terminal 38 Shifting the command to communication
Keypad running command channel	/	Terminal running command channel	Communication running command channel
Terminal running command channel	Keypad running command channel	/	Communication running command channel
Communication running command channel	Keypad running command channel	Terminal running command channel	/

**Note:** “/” means the multi-function terminal is invalid on the current reference channel.

Relative parameters table:

### 7.3 Vector control

Because asynchronous motors have the characteristics of high stage, nonlinear, strong coupling and various variables, the actual control of the asynchronous motor is very difficult. Vector control is mainly used to settle this problem with the theme of that divide the stator current vector into exciting current (the current heft generating internal magnetic field of the motor) and torque current (the current heft generating torque) by controlling and measuring the stator current vector according to the principles of beamed magnetic field to control the range and phase of these two hefts. This method can realize the decoupling of exciting current and torque current to adjust the high performance of asynchronous motors.

MSI200A series inverters are embedded speedless sensor vector control calculation for driving both asynchronous motors and synchronous motors. Because the core calculation of vector control is based on exact motor parameter models, the accuracy of motor parameter will impact on the performance of vector control. It is recommended to input the motor parameters and carry out autotune before vector running.

Because the vector control calculation is vary complicated, high technical theory is needed for the user during internal autotune. It is recommended to use the specific function parameters in vector control with cautions.

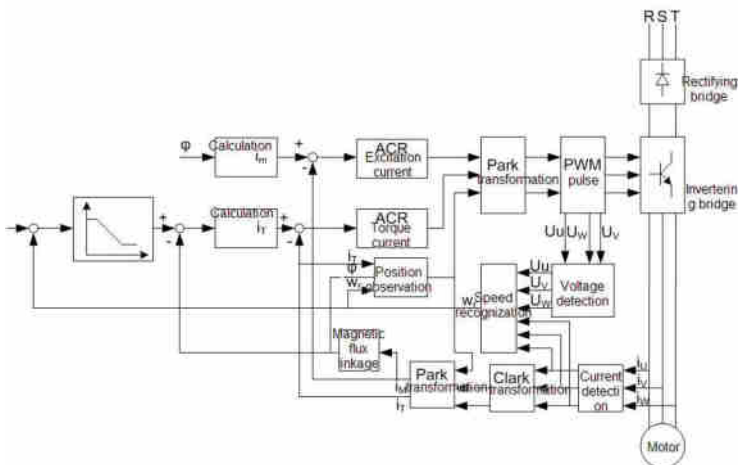

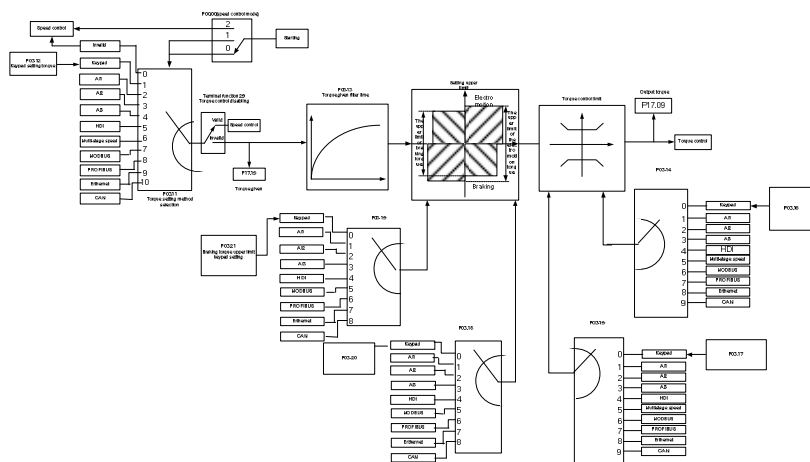

## 7.4 Torque control

MSI200A series inverters support two kinds of control mode: torque control and rotation speed control. The core of rotation speed control is that the whole control focuses on the stable speed and ensures the setting speed is the same as the actual running speed. The Max. Load should be in the range of the torque limit. The core of torque control is that the whole control focuses on the stable torque and ensures the setting torque is the same as the actual output torque. At the same time, the output frequency is among the upper limit or the lower limit.





## 7.5 Parameters of the motor

	<ul style="list-style-type: none"> <li>✧ Physical accident may occur if the motor starts up suddenly during autotune. Please check the safety of surrounding environment of the motor and the load before autotune.</li> <li>✧ The power is still applied even the motor stops running during static autotune. Please do not touch the motor until the autotune is completed, otherwise there would be electric shock.</li> </ul>
	<ul style="list-style-type: none"> <li>✧ Do not carry out the rotation autotune if the motor is coupled with the load, please do not operate on the rotation autotune. Otherwise misaction or damage may occur to the inverter or the mechanical devices. When carry out autotune on the motor which is coupled with load, the motor parameter won't be counted correctly and misaction may occur. It is proper to de-couple the motor from the load during autotune when necessary.</li> </ul>

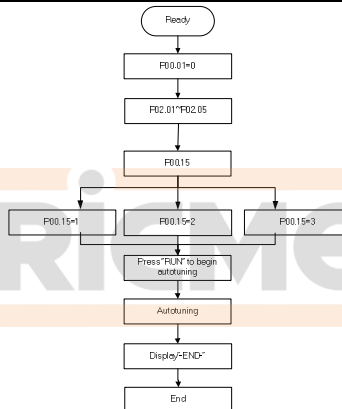

The control performance of the inverter is based on the established accurate motor model. The user has to carry out the motor autotune before first running (take motor 1 as the example).

### Note:

1. Set the motor parameters according to the name plate of the motor.
2. During the motor autotune, de-couple the motor from the load if rotation autotune is selected to make the motor is in a static and empty state, otherwise the result of autotune is incorrect. The asynchronous motors can autotune the parameters of P02.06~P02.10.
3. During the motor autotune 1, do not to de-couple the motor from the load if static autotune is selected. Because only some parameters of the motor are involved, the control performance is not as better as the rotation autotune. The asynchronous motors can autotune the parameters of P02.06~P02.10.
4. During the motor autotune 2, do not to de-couple the motor from the load if static autotune is selected. Because only some parameters of the motor are involved, the control performance is not as better as the rotation autotune. The asynchronous motors can autotune the parameters of P02.06~P02.08. It is suitable in the cases which SVPWM control is applied.

## 7.6 Start-up and stop control

The start-up and stop control of the inverter includes three states: start after the running command during normal powering on, start after the restarting function becomes valid during normal powering on and start after the automatic fault reset. Below is the detailed instruction for three starting.

There are three starting modes for the inverter: start from the starting frequency directly, start after the DC braking and start after the rotation speed tracking. The user can select according to different situations to meet their needs.

For the load with big inertia, especially in the cases where the reverse rotation may occur, it is better to select starting after DC braking and then starting after rotation speed tracking.

1. The starting logic figure of starting after the running command during the normal powering on

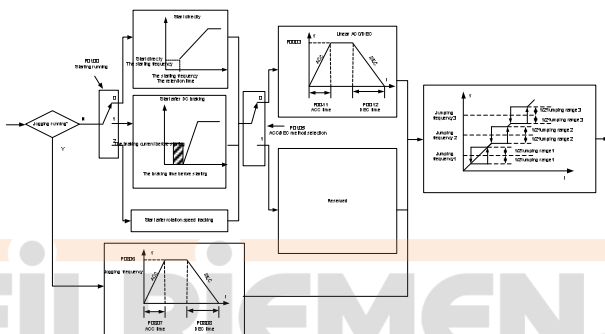

2. The starting logic figure of starting after the restarting function becomes valid during the normal powering on

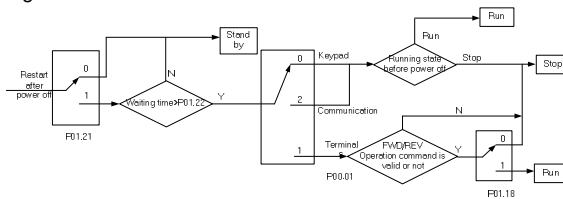

3. The starting logic figure of starting after the automatic fault reset

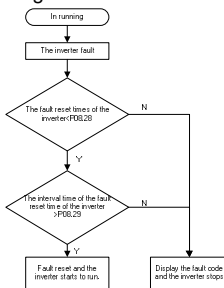

## 7.7 Frequency setting

MSI200A series inverters can set the frequency by various means. The reference channel can be divided into main reference channel and assistant reference channel.

There are two main reference channels: A frequency reference channel and B frequency reference channel. These two reference channels can carry out mutual simple math calculation between each other. And the reference channels can be shifted dynamically through set multi- function terminals.

There are three assistant reference channels: keypad UP/DOWN input, terminals UP/DOWN switch input and digital potentiometer input. The three ways equal to the effect of input UP/DOWN reference in internal assistant reference of the inverter. The user can enable the reference method and the effect of the method to the frequency reference by setting function codes.

The actual reference of the inverter is consisted of main reference channel and assistant reference channel.

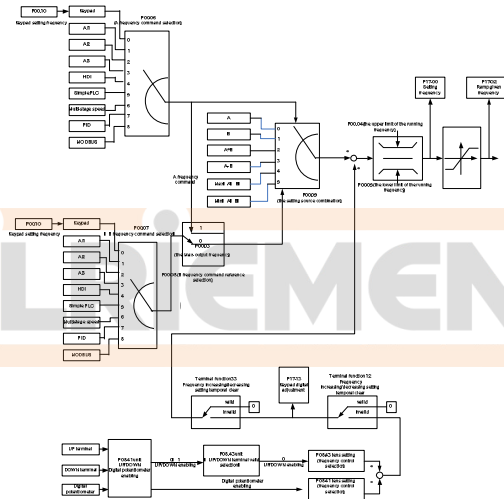

MSI200A series inverters support the shifting between different reference channels and the detailed shifting rules is as below:

Current reference channel P00.09	Multi-function terminal function 13 Shifting from A channel to B channel	Multi-function terminal function 14 Shifting from combination setting to A channel	Multi-function terminal function 15 Shifting from combination setting to B channel
A	B	/	/
B	/	/	/
A+B	/	A	B
A-B	/	A	B
Max(A,B)	/	A	B
Min(A,B)	/	A	B

**Note:** “/” means the multi-function terminal is invalid under the current reference channel.

When select multi-function terminal UP (10) and DOWN (11) to set the internal assistant frequency, P08.44 and P08.45 can be set to increase or decrease the set frequency quickly.

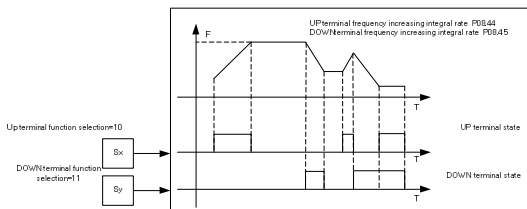

## 7.8 Simple PLC

Simple PLC function is also a multi-step speed generator. The inverter can change the running frequency, direction to meet the need of processing according to the running time automatically. In the past, this function needs to be assisted by external PLC, but now the inverter can realize this function by itself.

The series inverters can control 16-step speed with 4 groups of ACC/DEC time.

The multi-function digital output terminals or multi-function relay output an ON signal when the set PLC finishes a circle (or a step).

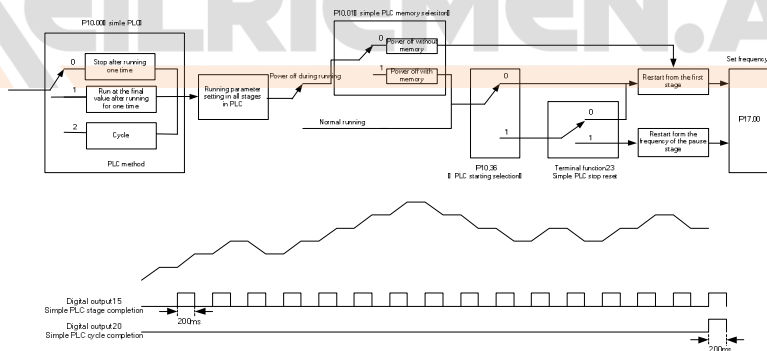

## 7.9 Multi-step speed running

Set the parameters when the inverter carries out multi-step speed running. MSI200A series inverters can set 16 step speed which can be selected by the combination code of multi-step speed terminals 1~4. They correspond to multi-step speed 0 to 15.

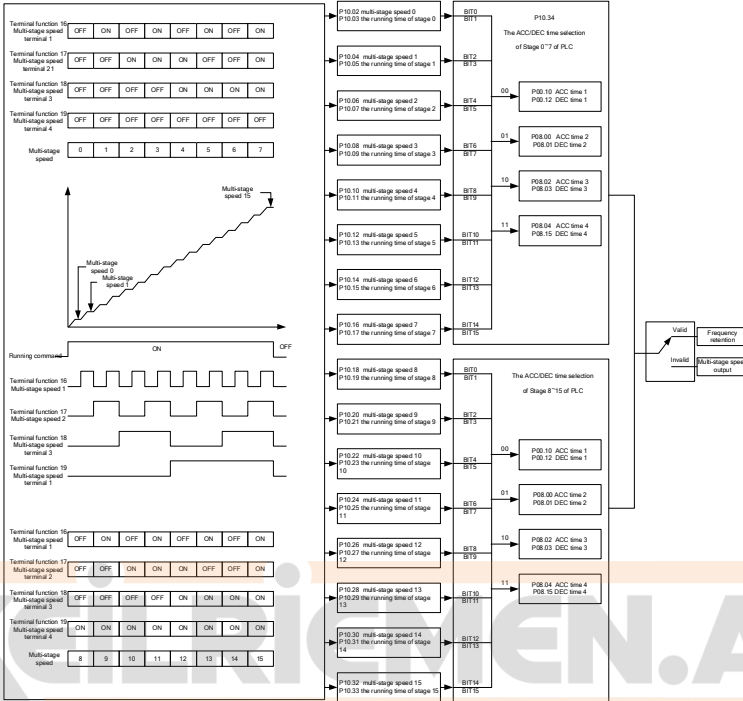

## 7.10 PID control

PID control is commonly used to control the procedure. Adjust the output frequency by proportional, integral, differential operation with the dispersion of the target signals to stabilize the value on the target. It is possible to apply to the flow, pressure and temperature control. Figure of basic control is as below:

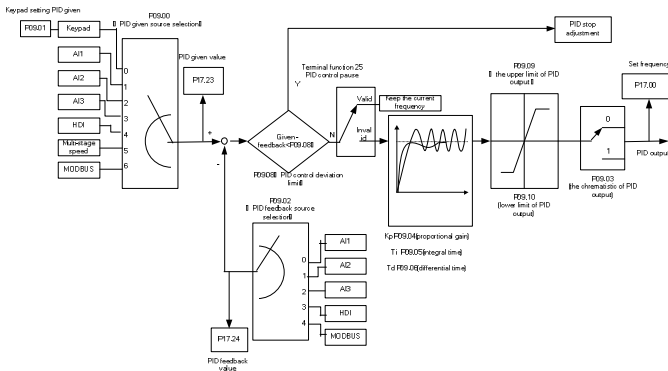

When P00.06, P00.07=7 or P04.27=6, the running mode of the inverter is procedure PID control.

### 7.15.1 General steps of PID parameters setting:

#### a Ensure the gain P

When ensure the gain P, firstly cancel the PID integration and derivation (set  $T_i=0$  and  $T_d=0$ , see the PID parameter setting for detailed information) to make proportional adjustment is the only method to PID. Set the input as 60%~70% of the permitted Max. Value and increase gain P from 0 until the system vibration occurs, vice versa, and record the PID value and set it to 60%~70% of the current value. Then the gain P commission is finished.

#### b Ensure the integration time

After ensuring the gain P, set an original value of a bigger integration time and decrease it until the system vibration occurs, vice versa, until the system vibration disappear. Record the  $T_i$  and set the integration time to 150%~180% of the current value. Then integration time commission is finished.

#### c Ensure the derivation time

Generally, it is not necessary to set  $T_d$  which is 0.

If it needs to be set, set it to 30% of the value without vibration via the same method with P and  $T_i$ .

d Commission the system with and without load and then adjust the PID parameter until it is available.

### 7.15.2 PID inching

After setting the PID control parameters, inching is possible by following means:

#### Control the overshoot

Shorten the derivation time and prolong the integration time when overshoot occurs.

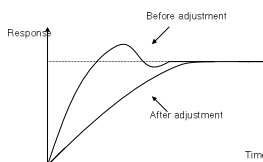

#### Achieve the stable state as soon as possible

Shorten the integration time ( $T_i$ ) and prolong the derivation time ( $T_d$ ) even the overshoot occurs, but the control should be stable as soon as possible.

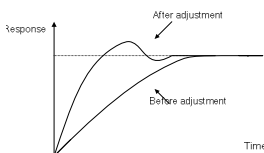

#### Control long vibration

If the vibration periods are longer than the set value of integration time ( $T_i$ ), it is necessary to prolong the integration time ( $T_i$ ) to control the vibration for the strong integration.

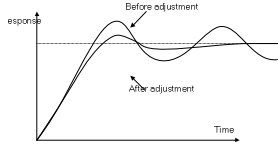

**Control short vibration**

Short vibration period and the same set value with the derivation time (Td) mean that the derivation time is strong. Shortening the derivation time (Td) can control the vibration. When setting the derivation time as 0.00(ire no derivation control) is useless to control the vibration, decrease the gain.

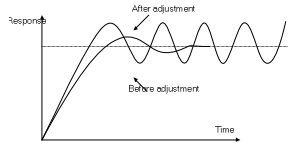

**7.11 Pulse counter**

MSI200A series inverters support pulse counter which can input counting pulse through HDI terminal. When the actual length is longer than or equal to the set length, the digital output terminal can output length arrival pulse signal and the corresponding length will be cleared automatically.

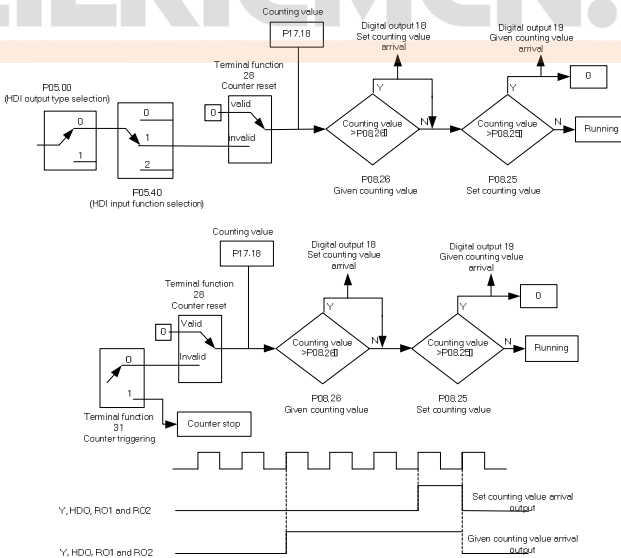

## 8 Fault Tracking

### 8.1 What this chapter contains

This chapter describes how to reset faults and view fault history. It also lists all alarm and fault messages including the possible cause and corrective actions.

	<p>⚡ <b>Only qualified electricians are allowed to maintain the inverter. Read the safety instructions in chapter Safety precautions before working on the inverter.</b></p>
---	--

### 8.2 Alarm and fault indications

Fault is indicated by LEDs. See **Operation Procedure**. When **TRIP** light is on, an alarm or fault message on the panel display indicates abnormal inverter state. Using the information reference in this chapter, most alarm and fault cause can be identified and corrected. If not, contact with the MORGENSEN office.

### 8.3 How to reset

The inverter can be reset by pressing the keypad key **STOP/RST**, through digital input, or by switching the power light. When the fault has been removed, the motor can be restarted.

### 8.4 Fault history

Function codes P07.27~P07.32 store 6 recent faults. Function codes P07.33~P07.40, P07.41~P7.48 and P07.49~P07.56 show drive operation data when the latest 3 faults occurs.

### 8.5 Fault instruction and solution

Do as the following after the inverter fault:

1. Check to ensure there is nothing wrong with the keypad. If not, please contact with the local MORGENSEN office.
2. If there is nothing wrong, please check P07 and ensure the corresponding recorded fault parameters to confirm the real state when the current fault occurs by all parameters.
3. See the following table for detailed solution and check the corresponding abnormal state.
4. Eliminate the fault and ask for relative help.
5. Check to eliminate the fault and carry out fault reset to run the inverter.

Fault code	Fault type	Possible cause	What to do
OU1	IGBT Ph-U fault	●The acceleration is too fast	<ul style="list-style-type: none"> <li>●Increase Acc time</li> <li>●Change the power unit</li> <li>●Check the driving wires</li> <li>●Inspect external equipment and eliminate interference</li> </ul>
OU2	IGBT Ph-V fault	<ul style="list-style-type: none"> <li>●IGBT module fault</li> <li>●Misaction caused by interference</li> </ul>	
OU3	IGBT Ph-W fault	<ul style="list-style-type: none"> <li>●The connection of the driving wires is not good,</li> <li>●Grounding is not properly</li> </ul>	
OC1	Over-current when acceleration	●The acceleration or deceleration is too fast	<ul style="list-style-type: none"> <li>●Increase the ACC time</li> <li>●Check the input power</li> </ul>



Fault code	Fault type	Possible cause	What to do
OC2	Over-current when deceleration	<ul style="list-style-type: none"> <li>●The voltage of the grid is too low</li> </ul>	<ul style="list-style-type: none"> <li>●Select the inverter with a larger power</li> </ul>
OC3	Over-current when constant speed running	<ul style="list-style-type: none"> <li>●The power of the inverter is too low</li> <li>●The load transients or is abnormal</li> <li>●The grounding is short circuited or the output is phase loss</li> <li>●There is strong external interference</li> <li>●The overvoltage stall protection is not open</li> </ul>	<ul style="list-style-type: none"> <li>●Check if the load is short circuited (the grounding short circuited or the wire short circuited) or the rotation is not smooth</li> <li>●Check the output configuration.</li> <li>●Check if there is strong interference</li> <li>●Check the setting of relative function codes</li> </ul>
OV1	Over-voltage when acceleration	<ul style="list-style-type: none"> <li>●The input voltage is abnormal</li> <li>●There is large energy feedback</li> <li>●No braking components</li> <li>●Braking energy is not open</li> </ul>	<ul style="list-style-type: none"> <li>●Check the input power</li> <li>●Check if the DEC time of the load is too short or the inverter starts during the rotation of the motor or it needs to add the dynamic braking components</li> <li>●Install the braking components</li> <li>●Check the setting of relative function codes</li> </ul>
OV2	Over-voltage when deceleration		
OV3	Over-voltage when constant speed running		
UV	DC bus Under-voltage	<ul style="list-style-type: none"> <li>●The voltage of the power supply is too low</li> <li>●The overvoltage stall protection is not open</li> </ul>	<ul style="list-style-type: none"> <li>●Check the input power of the supply line</li> <li>●Check the setting of relative function codes</li> </ul>
OL1	Motor overload	<ul style="list-style-type: none"> <li>●The voltage of the power supply is too low</li> <li>●The motor setting rated current is incorrect</li> <li>●The motor stall or load transients is too strong</li> </ul>	<ul style="list-style-type: none"> <li>●Check the power of the supply line</li> <li>●Reset the rated current of the motor</li> <li>●Check the load and adjust the torque lift</li> </ul>
OL2	Inverter overload	<ul style="list-style-type: none"> <li>●The acceleration is too fast</li> <li>●Reset the rotating motor</li> <li>●The voltage of the power supply is too low</li> <li>●The load is too heavy</li> <li>●The motor power is too big</li> </ul>	<ul style="list-style-type: none"> <li>●Increase the ACC time</li> <li>●Avoid the restarting after stopping</li> <li>●Check the power of the supply line</li> <li>●Select an inverter with bigger power</li> <li>●Select a proper motor</li> </ul>
OL3	Electrical overload	<ul style="list-style-type: none"> <li>●The inverter will report overload pre-alarm according to the set value</li> </ul>	<ul style="list-style-type: none"> <li>●Check the load and the overload pre-alarm point.</li> </ul>

Fault code	Fault type	Possible cause	What to do
SPI	Input phase loss	<ul style="list-style-type: none"> <li>●Phase loss or fluctuation of input R,S,T</li> </ul>	<ul style="list-style-type: none"> <li>●Check input power</li> <li>●Check installation distribution</li> </ul>
SPO	Output phase loss	<ul style="list-style-type: none"> <li>●U,V,W phase loss input(or serious asymmetrical three phase of the load)</li> </ul>	<ul style="list-style-type: none"> <li>●Check the output distribution</li> <li>●Check the motor and cable</li> </ul>
OH1	Rectify overheat	<ul style="list-style-type: none"> <li>●Air duct jam or fan damage</li> <li>●Ambient temperature is too high</li> <li>●The time of overload running is too long</li> </ul>	<ul style="list-style-type: none"> <li>●Clean the air duct or the fan</li> <li>●Reduce the ambient temperature</li> </ul>
OH2	IGBT overheat		
EF	External fault	<ul style="list-style-type: none"> <li>●SI external fault input terminals action</li> </ul>	<ul style="list-style-type: none"> <li>●Check the external device input</li> </ul>
CE	Communication error	<ul style="list-style-type: none"> <li>●The baud rate setting is incorrect</li> <li>●Fault occurs to the communication wiring.</li> <li>●The communication address is wrong</li> <li>●There is strong interference to the communication</li> </ul>	<ul style="list-style-type: none"> <li>●Set proper baud rate</li> <li>●Check the communication connection distribution</li> <li>●Set proper communication address</li> <li>●Change or replace the connection distribution or improve the anti-interference capability</li> </ul>
ItE	Current detection fault	<ul style="list-style-type: none"> <li>●The connection of the control board is not good</li> <li>●Hoare components is broken</li> <li>●The modifying circuit is abnormal</li> </ul>	<ul style="list-style-type: none"> <li>●Check the connector and repatch</li> <li>●Change the hoare</li> <li>●Change the main control panel</li> </ul>
tE	Autotuning fault	<ul style="list-style-type: none"> <li>●The motor capacity does not comply with the inverter capability</li> <li>●The rated parameter of the motor does not set correctly.</li> <li>●The offset between the parameters autotuning and the standard parameter is huge</li> <li>●Autotune overtime</li> </ul>	<ul style="list-style-type: none"> <li>●Change the inverter mode</li> <li>●Set the rated parameter according to the motor name plate</li> <li>●Empty the motor load and reidentify</li> <li>●Check the motor connection and set the parameter.</li> <li>●Check if the upper limit frequency is above 2/3 of the rated frequency.</li> </ul>
EEP	EEPROM fault	<ul style="list-style-type: none"> <li>●Error of controlling the write and read of the parameters</li> <li>●Damage to EEPROM</li> </ul>	<ul style="list-style-type: none"> <li>●Press <b>STOP/RST</b> to reset</li> <li>●Change the main control panel</li> </ul>

Fault code	Fault type	Possible cause	What to do
PIDE	PID feedback fault	<ul style="list-style-type: none"> <li>●PID feedback offline</li> <li>●PID feedback source disappear</li> </ul>	<ul style="list-style-type: none"> <li>●Check the PID feedback signal</li> <li>●Check the PID feedback source</li> </ul>
bCE	Braking unit fault	<ul style="list-style-type: none"> <li>●Braking circuit fault or damage to the braking pipes</li> <li>●The external braking resistor is not sufficient</li> </ul>	<ul style="list-style-type: none"> <li>●Check the braking unit and change new braking pipe</li> <li>●Increase the braking resistor</li> </ul>
ETH1	Grounding shortcut fault 1	<ul style="list-style-type: none"> <li>●The output of the inverter is short circuited with the ground</li> </ul>	<ul style="list-style-type: none"> <li>●Check if the connection of the motor is normal or not</li> <li>●Change the hoare</li> </ul>
ETH2	Grounding shortcut fault 2	<ul style="list-style-type: none"> <li>●There is fault in the current detection circuit</li> </ul>	<ul style="list-style-type: none"> <li>●Change the main control panel</li> </ul>
dEu	Velocity deviation fault	<ul style="list-style-type: none"> <li>●The load is too heavy or stalled</li> </ul>	<ul style="list-style-type: none"> <li>●Check the load and ensure it is normal</li> <li>●Increase the detection time</li> <li>●Check whether the control parameters are normal</li> </ul>
STo	Maladjustment fault	<ul style="list-style-type: none"> <li>●The control parameters of the synchronous motors not set properly</li> <li>●The autoturn parameter is not right</li> <li>●The inverter is not connected to the motor</li> </ul>	<ul style="list-style-type: none"> <li>●Check the load and ensure it is normal</li> <li>●Check whether the control parameter is set properly or not</li> <li>●Increase the maladjustment detection time</li> </ul>
END	Time reach of factory setting	<ul style="list-style-type: none"> <li>●The actual running time of the inverter is above the internal setting running time</li> </ul>	<ul style="list-style-type: none"> <li>●Ask for the supplier and adjust the setting running time</li> </ul>
PCE	Keypad communication fault	<ul style="list-style-type: none"> <li>●The connection of the keypad wires is not good or broken</li> <li>●The keypad wire is too long and affected by strong interference</li> <li>●There is circuit fault on the communication of the keypad and main board</li> </ul>	<ul style="list-style-type: none"> <li>●Check the keypad wires and ensure whether there is mistake</li> <li>●Check the environment and avoid the interference source</li> <li>●Change the hardware and ask for service</li> </ul>

Fault code	Fault type	Possible cause	What to do
DNE	Parameters downloading fault	<ul style="list-style-type: none"> <li>The connection of the keypad wires is not good or broken</li> <li>The keypad wire is too long and affected by strong interference</li> <li>There is mistake on the data storage of the keypad</li> </ul>	<ul style="list-style-type: none"> <li>Check the keypad wires and ensure whether there is mistake</li> <li>Change the hardware and ask for service</li> <li>Repack-up the data in the keypad</li> </ul>
LL	Electronic underload fault	<ul style="list-style-type: none"> <li>The inverter will report the underload pre-alarm according to the set value</li> </ul>	<ul style="list-style-type: none"> <li>Check the load and the underload pre-alarm point</li> </ul>

### 8.5.2 Other states

Fault code	Fault type	Possible cause	What to do
PoFF	System power off	System power off or the bus voltage is too low	Check the grid
	Communication failure between the keypad and main control board	The keypad is not conneted correctly	Check the installation environment

## 8.6 Common fault analysis

### 8.6.1 The motor does not work

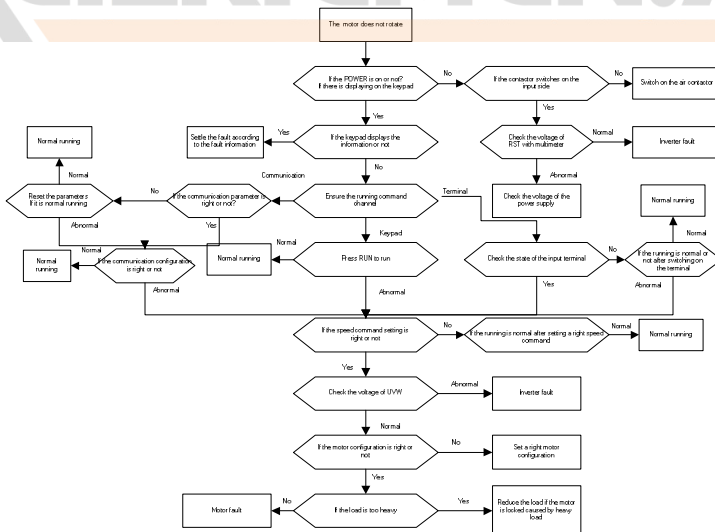

### 8.6.2 Motor vibration

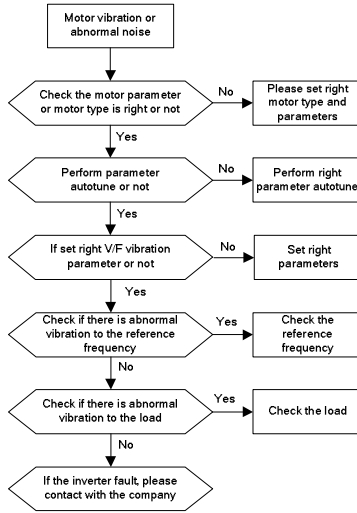

### 8.6.3 Overvoltage

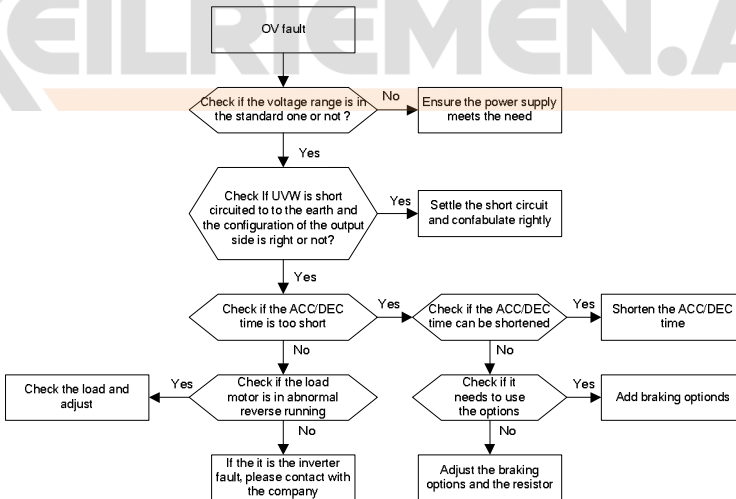

### 8.6.4 Undervoltage fault

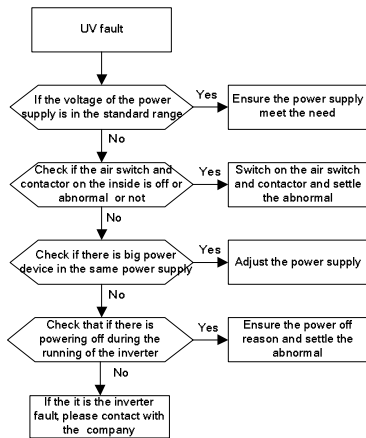

### 8.6.5 Abnormal motor heat

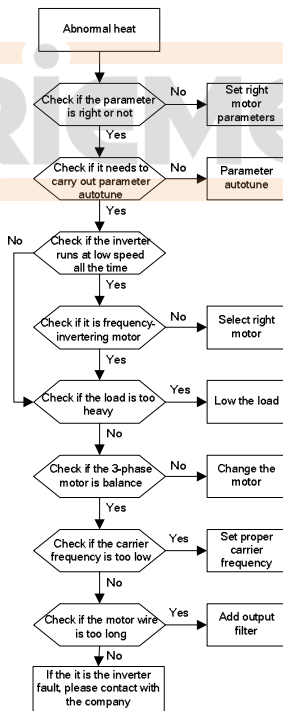

### 8.6.6 Inverter overheating

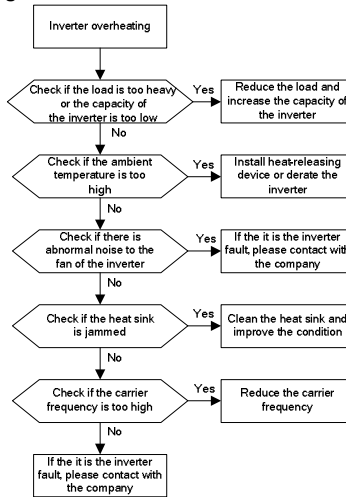

### 8.6.7 Stall during the acceleration of the motor

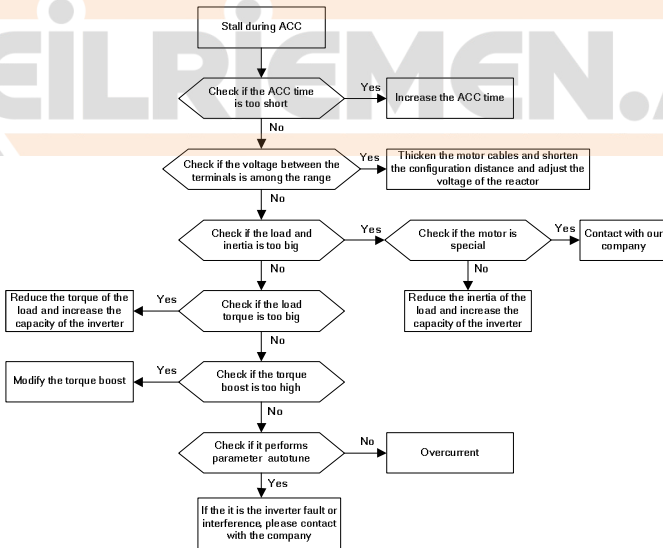

### 8.6.8 Overcurrent

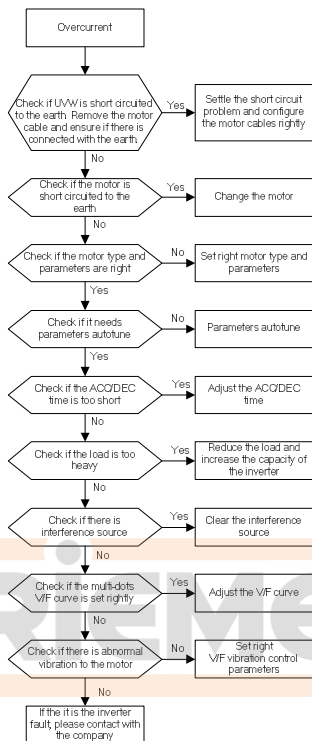

### 8.7 Inverter system interference troubleshooting

If sensitive devices(PLC,PC,sensors,test equipment,etc.) exist interference problems when the system is running, you can troubleshoot by the following means:

1. Try plugging in or unplugging the jumper pins of C3 filter to verify whether the interference has been eliminated.
2. Check whether the drive power lines and the signal/ communication lines of sensitive equipment go down the same trough, if there is, it should be again separated from the wiring.
3. If the sensitive equipment and drive to take power from the same grid, it is recommended to install isolation transformer and filter to the distribution of sensitive equipment side.
4. The relative shield wire of sensitive equipment try to ground at both ends、single-grounded、ungrounded respectively; to verify whether the interference has been eliminated.
5. Try to make the interfered sensitive equipment and the drive have no common ground, or floating processing; to verify whether the interference has been eliminated.



## 8.8 Maintenance and hardware diagnostics

### 8.8.1 Overcurrent

If installed in an appropriate environment, the inverter requires very little maintenance. The table lists the routine maintenance intervals recommended by MORGENSEN.

Checking part	Checking item	Checking method	Criterion
Ambient environment	Check the ambient temperature, humidity and vibration and ensure there is no dust, gas, oil fog and water drop.	Visual examination and instrument test	Conforming to the manual
	Ensure there are no tools or other foreign or dangerous objects	Visual examination	There are no tools or dangerous objects.
Voltage	Ensure the main circuit and control circuit are normal.	Measurement by millimeter	Conforming to the manual
Keypad	Ensure the display is clear enough	Visual examination	The characters are displayed normally.
	Ensure the characters are displayed totally	Visual examination	Conforming to the manual
Main circuit	Ensure the screws are tightened up	Tighten up	NA
	Ensure there is no distortion, crackles, damage or color-changing caused by overheating and aging to the machine and insulator.	Visual examination	NA
	Ensure there is no dust and dirtiness	Visual examination	NA <b>Note:</b> if the color of the copper blocks change, it does not mean that there is something wrong with the features.
	Ensure that there is no distortion or color-changing of the conductors caused by overheating.	Visual examination	NA
	Ensure that there are no	Visual	NA

Checking part		Checking item	Checking method	Criterion
		crackles or color-changing of the protective layers.	examination	
	Terminals seat	Ensure that there is no damage	Visual examination	NA
	Filter capacitors	Ensure that there is no weeping, color-changing, crackles and cassis expansion.	Visual examination	NA
		Ensure the safety valve is in the right place.	Estimate the usage time according to the maintenance or measure the static capacity.	NA
		If necessary, measure the static capacity.	Measure the capacity by instruments.	The static capacity is above or equal to the original value *0.85.
	Resistors	Ensure whether there is replacement and splitting caused by overheating.	Smelling and visual examination	NA
		Ensure that there is no offline.	Visual examination or remove one ending to coagulate or measure with multimeters	The resistors are in $\pm 10\%$ of the standard value.
	Transformers and reactors	Ensure there is no abnormal vibration, noise and smelling,	Hearing, smelling and visual examination	NA
	Electromagnetism contactors and relays	Ensure whether there is vibration noise in the workrooms.	Hearing	NA
		Ensure the contactor is good enough.	Visual examination	NA
Control circuit	PCB and plugs	Ensure there are no loose screws and contactors.	Fasten up	NA
		Ensure there is no smelling and color-changing.	Smelling and visual examination	NA
		Ensure there are no	Visual	NA

Checking part		Checking item	Checking method	Criterion
		crackles, damage distortion and rust.	examination	
		Ensure there is no weeping and distortion to the capacitors.	Visual examination or estimate the usage time according to the maintenance information	NA
Cooling system	Cooling fan	Estimate whether there is abnormal noise and vibration.	Hearing and Visual examination or rotate with hand	Stable rotation
		Estimate there is no losses screw.	Tighten up	NA
		Ensure there is no color-changing caused by overheating.	Visual examination or estimate the usage time according to the maintenance information	NA
	Ventilating duct	Ensure whether there is stuff or foreign objection in the cooling fan, air vent.	Visual examination	NA

Consult the local service representative for more details on the maintenance. Visit the official website of MORGENSEN: <http://www.morgensen.de> and select Inverter Services – Maintenance and Services.

### 8.8.2 Cooling fan

The inverter's cooling fan has a minimum life span of 25,000 operating hours. The actual life span depends on the inverter usage and ambient temperature.

The operating hours can be found through P07.14 (accumulative hours of the inverter).

Fan failure can be predicted by the increasing noise from the fan bearings. If the inverter is operated in a critical part of a process, fan replacement is recommended once these symptoms appear. Replacement fans are available from MORGENSEN.

### 8.8.2.1 Replacing the cooling fan



✧ **Read and follow the instructions in chapter *Safety Precautions*. Ignoring the instructions would cause physical injury or death, or damage to the equipment.**

1. Stop the inverter and disconnect it from the AC power source and wait for at least the time designated on the inverter.
2. Lever the fan holder off the drive frame with a screwdriver and lift the hinged fan holder slightly upward from its front edge.
3. Loose the fan cable from the clip.
4. Disconnect the fan cable.
5. Remove the fan holder from the hinges.
6. Install the new fan holder including the fan in reverse order.
7. Restore power.

### 8.8.3 Capacitors

#### 8.8.3.1 Reforming the capacitors

The DC bus capacitors must be reformed according to the operation instruction if the inverter has been stored for a long time. The storing time is counted from the producing date other than the delivery data which has been marked in the serial number of the inverter.

Time	Operational principle
Storing time less than 1 year	Operation without charging
Storing time 1-2 years	Connect with the power for 1 hour before first ON command
Storing time 2-3 years	Use power surge to charge for the inverter <ul style="list-style-type: none"> <li>• Add 25% rated voltage for 30 minutes</li> <li>• Add 50% rated voltage for 30 minutes</li> <li>• Add 75% rated voltage for 30 minutes</li> <li>• Add 100% rated voltage for 30 minutes</li> </ul>
Storing time more than 3 years	Use power surge to charge for the inverter <ul style="list-style-type: none"> <li>• Add 25% rated voltage for 2 hours</li> <li>• Add 50% rated voltage for 2 hours</li> <li>• Add 75% rated voltage for 2 hours</li> <li>• Add 100% rated voltage for 2 hours</li> </ul>

The method of using power surge to charge for the inverter:

The right selection of Power surge depends on the supply power of the inverter. Single phase 220V AC/2A power surge applied to the inverter with single/three-phase 220V AC as its input voltage. The inverter with single/three-phase 220V AC as its input voltage can apply Single phase 220V AC/2A power surge. All DC bus capacitors charge at the same time because there is one rectifier.

High-voltage inverter needs enough voltage (for example, 380V) during charging. The small capacitor power (2A is enough) can be used because the capacitor nearly does not need current when charging.

The operation method of inverter charging through resistors (LEDs):

The charging time is at least 60 minutes if charge the DC bus capacitor directly through supply power. This operation is available on normal temperature and no-load condition and

the resistor should be serially connected in the 3-phase circuits of the power supply(the distance between resistors of each phase $\geq$ 5.5mm):

380V drive device: 1k/100W resistor. LED of 100W can be used when the power voltage is no more than 380V. But if used, the light may be off or weak during charging.

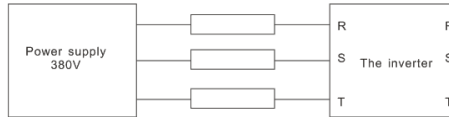

380V charging illustration of the driven device

### 8.8.3.2 Change electrolytic capacitors



◇**Read and follow the instructions in chapter *Safety Precautions*. Ignoring the instructions may cause physical injury or death, or damage to the equipment.**

Change electrolytic capacitors if the working hours of electrolytic capacitors in the inverter are above 35000. Please contact with the local MORGENSEN offices or dial our national service hotline (400-700-9997) for detailed operation.

### 8.8.4 Power cable



◇**Read and follow the instructions in chapter *Safety Precautions*. Ignoring the instructions may cause physical injury or death, or damage to the equipment.**

1. Stop the drive and disconnect it from the power line. Wait for at least the time designated on the inverter.
2. Check the tightness of the power cable connections.
3. Restore power.

## 9 Communication Protocol

---

### 9.1 What this chapter contains

This chapter describes the communication protocol of MSI200A series inverters.

The MSI200A series inverters provide RS485 communication interface. It adopts international standard MODBUS communication protocol to perform master-slave communication. The user can realize centralized control through PC/PLC, upper control PC, etc. (set the control command, running frequency of the inverter, modify relevant function codes, monitor and control the operating state and fault information of the inverter and so on) to adapt specific application requirements.

### 9.2 Brief instruction to MODBUS protocol

MODBUS protocol is a software protocol and common language which is applied in the electrical controller. With this protocol, the controller can communicate with other devices via network (the channel of signal transmission or the physical layer, such as RS485). And with this industrial standard, the controlling devices of different manufacturers can be connected to an industrial network for the convenient of being monitored.

There are two transmission modes for MODBUS protocol: ASCII mode and RTU (Remote Terminal Units) mode. On one MODBUS network, all devices should select same transmission mode and their basic parameters, such as baud rate, digital bit, check bit, and stopping bit should have no difference.

MODBUS network is a controlling network with single-master and multiple slaves, which means that there is only one device performs as the master and the others are the slaves on one MODBUS network. The master means the device which has active talking right to sent message to MODBUS network for the controlling and inquiring to other devices. The slave means the passive device which sends data message to the MODBUS network only after receiving the controlling or inquiring message (command) from the master (response). After the master sends message, there is a period of time left for the controlled or inquired slaves to response, which ensure there is only one slave sends message to the master at a time for the avoidance of singles impact.

Generally, the user can set PC, PLC, IPC and HMI as the masters to realize central control. Setting certain device as the master is a promise other than setting by a bottom or a switch or the device has a special message format. For example, when the upper monitor is running, if the operator clicks sending command bottom, the upper monitor can send command message actively even it can not receive the message from other devices. In this case, the upper monitor is the master. And if the designer makes the inverter send the data only after receiving the command, then the inverter is the slave.

The master can communicate with any single slave or with all slaves. For the single-visiting command, the slave should feedback a response message; for the broadcasting message from the master, the slave does not need to feedback the response message.

### 9.3 Application of the inverter

The MODBUS protocol of the inverter is RTU mode and the physical layer is 2-wire RS485.

### 9.3.1 RS485

The interface of 2-wire RS485 works on semiduplex and its data signal applies differential transmission which is called balance transmission, too. It uses twisted pairs, one of which is defined as A (+) and the other is defined as B (-). Generally, if the positive electrical level between sending drive A and B is among +2~+6V, it is logic“1”, if the electrical level is among -2V~-6V; it is logic“0”.

485+ on the terminal board corresponds to A and 485- to B.

Communication baud rate means the binary bit number in one second. The unit is bit/s (bps). The higher the baud rate is, the quicker the transmission speed is and the weaker the anti-interference is. If the twisted pairs of 0.56mm ( 24AWG ) is applied as the communication cables, the Max. Transmission distance is as below:

Baud rate	Max. transmission distance	Baud rate	Max. transmission distance
2400BPS	1800m	9600BPS	800m
4800BPS	1200m	19200BPS	600m

It is recommended to use shield cables and make the shield layer as the grounding wires during RS485 remote communication.

In the cases with less devices and shorter distance, it is recommended to use 120Ω terminal resistor as the performance will be weakened if the distance increase even though the network can perform well without load resistor.

### 9.3.2 RTU mode

#### 9.3.2.1 RTU communication frame format

If the controller is set to communicate by RTU mode in MODBUS network every 8bit byte in the message includes two 4Bit hex characters. Compared with ACSII mode, this mode can send more data at the same baud rate.

#### Code system

- 1 start bit
- 7 or 8 digital bit, the minimum valid bit can be sent firstly. Every 8 bit frame includes two hex characters (0...9, A...F)
- 1 even/odd check bit . If there is no checkout, the even/odd check bit is inexistent.
- 1 end bit (with checkout), 2 Bit(no checkout)

#### Error detection field

- CRC

The data format is illustrated as below:

11-bit character frame (BIT1~BIT8 are the digital bits)

Start bit	BIT1	BIT2	BIT3	BIT4	BIT5	BIT6	BIT7	BIT8	Check bit	End bit
-----------	------	------	------	------	------	------	------	------	-----------	---------

10-bit character frame (BIT1~BIT7 are the digital bits)

Start bit	BIT1	BIT2	BIT3	BIT4	BIT5	BIT6	BIT7	Check bit	End bit
-----------	------	------	------	------	------	------	------	-----------	---------

In one character frame, the digital bit takes effect. The start bit, check bit and end bit is used to send the digital bit right to the other device. The digital bit, even/odd checkout and end bit should be set as the same in real application.

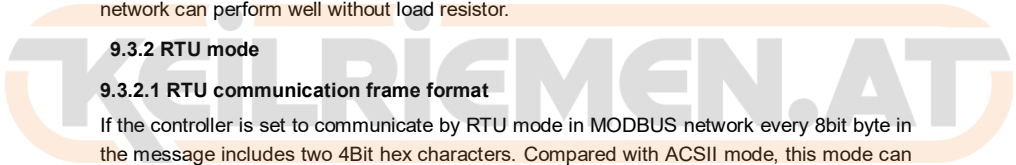

The MODBUS minimum idle time between frames should be no less than 3.5 bytes. The network device is detecting, even during the interval time, the network bus. When the first field (the address field) is received, the corresponding device decodes next transmitting character. When the interval time is at least 3.5 byte, the message ends.

The whole message frame in RTU mode is a continuous transmitting flow. If there is an interval time (more than 1.5 bytes) before the completion of the frame, the receiving device will renew the uncompleted message and suppose the next byte as the address field of the new message. As such, if the new message follows the previous one within the interval time of 3.5 bytes, the receiving device will deal with it as the same with the previous message. If these two phenomena all happen during the transmission, the CRC will generate a fault message to respond to the sending devices.

The standard structure of RTU frame:

START	T1-T2-T3-T4(transmission time of 3.5 bytes)
ADDR	Communication address: 0~247(decimal system)(0 is the broadcast address)
CMD	03H:read slave parameters 06H:write slave parameters
DATA (N-1) ... DATA (0)	The data of 2*N bytes are the main content of the communication as well as the core of data exchanging
CRC CHK low bit	Detection value:CRC (16BIT)
CRC CHK high bit	
END	T1-T2-T3-T4(transmission time of 3.5 bytes)

### 9.3.2.2 RTU communication frame error checkout

Various factors (such as electromagnetic interference) may cause error in the data transmission. For example, if the sending message is a logic "1", A-B potential difference on RS485 should be 6V, but in reality, it may be -6V because of electromagnetic interference, and then the other devices take the sent message as logic "0". If there is no error checkout, the receiving devices will not find the message is wrong and they may give incorrect response which cause serious result. So the checkout is essential to the message.

The theme of checkout is that: the sender calculate the sending data according to a fixed formula, and then send the result with the message. When the receiver gets this message, they will calculate another result according to the same method and compare it with the sending one. If two results are the same, the message is correct. If not, the message is incorrect.

The error checkout of the frame can be divided into two parts: the bit checkout of the byte and the whole data checkout of the frame (CRC check).

#### Bit checkout of the byte

The user can select different bit checkouts or non-checkout, which impacts the check bit setting of each byte.

The definition of even checkout: add an even check bit before the data transmission to illustrate the number of "1" in the data transmission is odd number or even number. When it is even, the check byte is "0", otherwise, the check byte is "1". This method is used to stabilize



the parity of the data.

The definition of odd checkout: add an odd check bit before the data transmission to illustrate the number of “1” in the data transmission is odd number or even number. When it is odd, the check byte is “0”, otherwise, the check byte is “1”. This method is used to stabilize the parity of the data.

For example, when transmitting “11001110”, there are five “1” in the data. If the even checkout is applied, the even check bit is “1”; if the odd checkout is applied; the odd check bit is “0”. The even and odd check bit is calculated on the check bit position of the frame. And the receiving devices also carry out even and odd checkout. If the parity of the receiving data is different from the setting value, there is an error in the communication.

### **CRC check**

The checkout uses RTU frame format. The frame includes the frame error detection field which is based on the CRC calculation method. The CRC field is two bytes, including 16 figure binary values. It is added into the frame after calculated by transmitting device. The receiving device recalculates the CRC of the received frame and compares them with the value in the received CRC field. If the two CRC values are different, there is an error in the communication.

During CRC, 0\*FFFF will be stored. And then, deal with the continuous 6-above bytes in the frame and the value in the register. Only the 8Bit data in every character is effective to CRC, while the start bit, the end and the odd and even check bit is ineffective.

The calculation of CRC applies the international standard CRC checkout principles. When the user is editing CRC calculation, he can refer to the relative standard CRC calculation to write the required CRC calculation program.

Here provided a simple function of CRC calculation for the reference (programmed with C language):

```
unsigned int crc_cal_value(unsigned char *data_value,unsigned char data_length)
{
int i;
unsigned int crc_value=0xffff;
while(data_length--)
{   crc_value^=*data_value++;
        for(i=0;i<8;i++)
        {
if(crc_value&0x0001)crc_value=(crc_value>>1)^0xa001;
        else crc_value=crc_value>>1;
        }   }
return(crc_value);
}
```

In ladder logic, CKSM calculated the CRC value according to the frame with the table inquiry. The method is advanced with easy program and quick calculation speed. But the ROM space the program occupied is huge. So use it with caution according to the program required space.

## 9.4 RTU command code and communication data illustration

### 9.4.1 Command code: 03H

read N words (Word) (the Max. continuous reading is 16 words)

Command code 03H means that if the master read data form the inverter, the reading number depends on the “data number” in the command code. Max. continuous reading number is 16 and the parameter address should be continuous. The byte length of every data is 2 (one word). The following command format is illustrated by hex (a number with “H” means hex) and one hex occupies one byte.

The command code is used to read the working step of the inverter.

For example, read continuous 2 data content from 0004H from the inverter with the address of 01H (read the content of data address of 0004H and 0005H), the frame structure is as below:

RTU master command message (from the master to the inverter)

START	T1-T2-T3-T4 (transmission time of 3.5 bytes)
ADDR	01H
CMD	03H
High bit of the start address	00H
Low bit of the start address	04H
High bit of data number	00H
Low bit of data number	02H
CRC low bit	85H
CRC high bit	CAH
END	T1-T2-T3-T4 (transmission time of 3.5 bytes)

T1-T2-T3-T4 between START and END is to provide at least the time of 3.5 bytes as the leisure time and distinguish two messages for the avoidance of taking two messages as one message.

**ADDR** = 01H means the command message is sent to the inverter with the address of 01H and ADDR occupies one byte

**CMD**=03H means the command message is sent to read data form the inverter and CMD occupies one byte

“**Start address**” means reading data form the address and it occupies 2 bytes with the fact that the high bit is in the front and the low bit is in the behind.

“**Data number**” means the reading data number with the unit of word. If the “start address” is 0004H and the “data number” is 0002H, the data of 0004H and 0005H will be read.

**CRC** occupies 2 bytes with the fact that the high bit is in the front and the low bit is in the behind.

RTU slave response message (from the inverter to the master)

START	T1-T2-T3-T4 (transmission time of 3.5 bytes)
ADDR	01H
CMD	03H
Byte number	04H
Data high bit of address 0004H	13H

Data low bit of address 0004H	88H
Data high bit of address 0005H	00H
Data low bit of address 0005H	00H
CRC CHK low bit	7EH
CRC CHK high bit	9DH
END	T1-T2-T3-T4 (transmission time of 3.5 bytes)

The meaning of the response is that:

**ADDR** = 01H means the command message is sent to the inverter with the address of 01H and ADDR occupies one byte

**CMD**=03H means the message is received from the inverter to the master for the response of reading command and CMD occupies one byte

“**Byte number**” means all byte number from the byte(excluding the byte) to CRC byte(excluding the byte). 04 means there are 4 byte of data from the “byte number” to “CRC CHK low bit”, which are “digital address 0004H high bit”, “digital address 0004H low bit”, “digital address 0005H high bit” and “digital address 0005H low bit”.

There are 2 bytes stored in one data with the fact that the high bit is in the front and the low bit is in the behind of the message, the data of data address 0004H is 1388H, and the data of data address 0005H is 0000H.

CRC occupies 2 bytes with the fact that the high bit is in the front and the low bit is in the behind.

#### 9.4.2 Command code: 06H

06H (correspond to binary 0000 0110), write one word(Word)

The command means that the master write data to the inverter and one command can write one data other than multiple dates. The effect is to change the working mode of the inverter.

For example, write 5000 (1388H) to 0004H from the inverter with the address of 02H, the frame structure is as below:

RTU master command message (from the master to the inverter)

START	T1-T2-T3-T4(transmission time of 3.5 bytes)
ADDR	02H
CMD	06H
High bit of write data address	00H
Low bit of write data address	04H
High bit of data content	13H
Low bit of data content	88H
CRC CHK low bit	C5H
CRC CHK high bit	6EH
END	T1-T2-T3-T4 (transmission time of 3.5 bytes)

RTU slave response message (from the inverter to the master)

START	T1-T2-T3-T4 (transmission time of 3.5 bytes)
ADDR	02H
CMD	06H
High bit of writing data address	00H

Low bit of writing data address	04H
High bit of data content	13H
Low bit of data content	88H
CRC CHK low bit	C5H
CRC CHK high bit	6EH
END	T1-T2-T3-T4 (transmission time of 3.5 bytes)

**Note:** section 10.2 and 10.3 mainly describe the command format, and the detailed application will be mentioned in 10.8 with examples.

### 9.4.3 Command code 08H for diagnosis

Meaning of sub-function codes

Sub-function Code	Description
0000	Return to inquire information data

For example: The inquiry information string is same as the response information string when the loop detection to address 01H of driver is carried out.

The RTU request command is:

START	T1-T2-T3-T4 (transmission time of 3.5 bytes)
ADDR	01H
CMD	08H
High bit of sub-function code	00H
Low bit of sub-function code	00H
High bit of data content	12H
Low bit of data content	ABH
Low bit of CRC	ADH
High bit of CRC	14H
END	T1-T2-T3-T4 (transmission time of 3.5 bytes)

The RTU response command is:

START	T1-T2-T3-T4 (transmission time of 3.5 bytes)
ADDR	01H
CMD	08H
High bit of sub-function code	00H
Low bit of sub-function code	00H
High bit of data content	12H
Low bit of data content	ABH
Low bit of CRC	ADH
High bit of CRC	14H
END	T1-T2-T3-T4 (transmission time of 3.5 bytes)

### 9.4.4 Command code: 10H, continuous writing

Command code 10H means that if the master writes data to the inverter, the data number depends on the “data number” in the command code. The Max. continuous reading number is 16.

For example, write 5000(1388H) to 0004H of the inverter whose slave address is 02H and

50(0032H) to 0005H, the frame structure is as below:

The RTU request command is:

START	T1-T2-T3-T4 (transmission time of 3.5 bytes)
ADDR	02H
CMD	10H
High bit of write data	00H
Low bit of write data	04H
High bit of data number	00H
Low bit of data number	02H
Byte number	04H
High bit of data 0004H	13H
Low bit of data 0004H	88H
High bit of data 0005H	00H
Low bit of data 0005H	32H
Low bit of CRC	C5H
High bit of CRC	6EH
END	T1-T2-T3-T4 (transmission time of 3.5 bytes)

The RTU response command is:

START	T1-T2-T3-T4 (transmission time of 3.5 bytes)
ADDR	02H
CMD	10H
High bit of write data	00H
Low bit of write data	04H
High bit of data number	00H
Low bit of data number	02H
Low bit of CRC	C5H
High bit of CRC	6EH
END	T1-T2-T3-T4 (transmission time of 3.5 bytes)

#### 9.4.5 The definition of data address

The address definition of the communication data in this part is to control the running of the inverter and get the state information and relative function parameters of the inverter.

##### 9.4.5.1 The rules of parameter address of the function codes

The parameter address occupies 2 bytes with the fact that the high bit is in the front and the low bit is in the behind. The range of high and low byte are: high byte—00~ffH; low byte—00~ffH. The high byte is the group number before the radix point of the function code and the low byte is the number after the radix point. But both the high byte and the low byte should be changed into hex. For example P05.06, the group number before the radix point of the function code is 05, then the high bit of the parameter is 05, the number after the radix point 05, then the low bit of the parameter is 06, then the function code address is 0506H and the parameter address of P10.01 is 0A01H.

Function code	Name	Detailed instruction of parameters	Setting range	Default value	Modification	Serial No.
P10.00	Simple PLC restart	0: Stop after running once. 1: Run at the first value after running once. 2: Cycle running.	0-2	0	0	354
P10.01	Simple PLC memory selection	0: power loss without memory. 1: power loss memory.	0-1	0	0	355

**Note:** P29 group is the factory parameter which can not be read or changed. Some parameters can not be changed when the inverter is in the running state and some parameters can not be changed in any state. The setting range, unit and relative instructions should be paid attention to when modifying the function code parameters.

Besides, EEPROM is stocked frequently, which may shorten the usage time of EEPROM. For users, some functions are not necessary to be stocked on the communication mode. The needs can be met on by changing the value in RAM. Changing the high bit of the function code from 0 to 1 can also realize the function. For example, the function code P00.07 is not stocked into EEPROM. Only by changing the value in RAM can set the address to 8007H. This address can only be used in writing RAM other than reading. If it is used to read, it is an invalid address.

#### 9.4.5.2 The address instruction of other function in MODBUS

The master can operate on the parameters of the inverter as well as control the inverter, such as running or stopping and monitoring the working state of the inverter.

Below is the parameter list of other functions

Function instruction	Address definition	Data meaning instruction	R/W characteristics
Communication control command	2000H	0001H:forward running	W/R
		0002H:reverse running	
		0003H:forward jogging	
		0004H:reverse jogging	
		0005H:stop	
		0006H:coast to stop (emergency stop)	
		0007H:fault reset	
		0008H:jogging stop	
The address of the communication setting value	2001H	Communication setting frequency(0~Fmax(unit: 0.01Hz))	W/R
	2002H	PID reference, range(0~1000, 1000 corresponds to100.0% )	W/R
	2003H	PID feedback, range(0~1000, 1000 corresponds to100.0% )	W/R
	2004H	Torque setting value (-3000~3000, 1000	W/R

Function instruction	Address definition	Data meaning instruction	R/W characteristics
		corresponds to the 100.0% of the rated current of the motor)	
	2005H	The upper limit frequency setting during forward rotation(0~Fmax(unit: 0.01Hz))	W/R
	2006H	The upper limit frequency setting during reverse rotation(0~Fmax(unit: 0.01Hz))	W/R
	2007H	The upper limit torque of electromotion torque (0~3000, 1000 corresponds to the 100.0% of the rated current of the motor)	W/R
	2008H	The upper limit torque of braking torque (0~3000, 1000 corresponds to the 100.0% of the rated current of the motor)	W/R
	2009H	Special control command word Bit0~1:=00:motor 1 =01:motor 2 =10:motor 3 =11:motor 4 Bit2:=1 torque control =0:speed control	W/R
	200AH	Virtual input terminal command , range: 0x000~0x1FF	W/R
	200BH	Virtual input terminal command , range: 0x00~0x0F	W/R
	200CH	Voltage setting value(special for V/F separation) (0~1000, 1000 corresponds to the 100.0% of the rated voltage of the motor)	W/R
	200DH	AO output setting 1(-1000~1000, 1000 corresponds to 100.0%)	W/R
	200EH	AO output setting 2(-1000~1000, 1000 corresponds to 100.0%)	W/R
SW 1 of the inverter	2100H	0001H:forward running	R
		0002H:forward running	
		0003H:stop	
		0004H:fault	
		0005H: POFF state	
SW 2 of the inverter	2101H	Bit0: =0:bus voltage is not established =1:bus voltage is established Bi1~2:=00:motor 1 =01:motor 2 =10:motor 3 =11:motor 4 Bit3: =0:asynchronous motor =1:synchronous motor Bit4:=0:pre-alarm without overload =1:overload pre-alarm	R

Function instruction	Address definition	Data meaning instruction	R/W characteristics
		Bit5~ Bit6:=00:keypad control =01:terminal control =10:commuincation control	
Fault code of the inverter	2102H	See the fault type instruction	R
Identifying code of the inverter	2103H	MSI200A -----0x010C	R
Operation frequency	3000H	Range: 0.00Hz~P00.03	R
Setting frequency	3001H	Range: 0.00Hz~P00.03	R
Bus voltage	3002H	Range: 0~1200V	R
Output voltage	3003H	Range: 0~1200V	R
Output current	3004H	Range: 0.0~5000.0A	R
Operation speed	3005H	Range: 0~65535RPM	R
Output power	3006H	Range: -300.0~300.0%	R
Output torque	3007H	Range: 0~65535RPM	R
Close loop setting	3008H	Range: -100.0%~100.0%	R
Close loop feedback	3009H	Range: -100.0%~100.0%	R
Input IO state	300AH	Range: 0000~00FF	R
Output IO state	300BH	Range: 0000~00FF	R
AI 1	300CH	Range: 0.00~10.00V	R
AI 2	300DH	Range: 0.00~10.00V	R
AI 3	300EH	Range: 0.00~10.00V	R
AI 4	300FH	Reserved	R
Read high speed pulse 1 input	3010H	Range: 0.00~50.00kHz	R
Read high speed pulse 2 input	3011H	Reserved	R
Read current step of the multi-step speed	3012H	Range: 0~15	R
External length	3013H	Range: 0~65535	R
External counting value	3014H	Range: 0~65535	R
Torque setting	3015H	Range: 0~65535	R
Inverter code	3016H		R
Fault code	5000H		R

R/W characteristics means the function is with read and write characteristics. For example,



“communication control command” is writing characteristics and control the inverter with writing command (06H). R characteristic can only read other than write and W characteristic can only write other than read.

**Note:** when operate on the inverter with the table above, it is necessary to enable some parameters. For example, the operation of running and stopping, it is necessary to set P00.01 to communication running command channel and set P00.02 to MODBUS communication channel. And when operate on “PID reference”, it is necessary to set P09.00 to “MODBUS communication setting”.

The encoding rules for device codes (corresponds to identifying code 2103H of the inverter)

Code high 8 bit	Meaning	Code low 8 bit	Meaning
01	GD	0x08	GD35 vector inverters
		0x09	GD35-H1 vector inverters
		0x0a	GD300 vector inverters
		0x0b	GD100 simple vector inverters
		0x0c	MSI200A general inverters
		0x0d	GD10 mini inverters

**Note:** the code is consisted of 16 bit which is high 8 bits and low 8 bits. High 8 bits mean the motor type series and low 8 bits mean the derived motor types of the series. For example, 0110H means MSI200A vector inverters.

#### 9.4.6 Fieldbus ratio values

The communication data is expressed by hex in actual application and there is no radix point in hex. For example, 50.12Hz can not be expressed by hex so 50.12 can be magnified by 100 times into 5012, so hex 1394H can be used to express 50.12.

A non-integer can be timed by a multiple to get an integer and the integer can be called fieldbus ratio values.

The fieldbus ratio values are referred to the radix point of the setting range or default value in the function parameter list. If there are figures behind the radix point ( $n=1$ ), then the fieldbus ratio value  $m$  is  $10^n$ . Take the table as the example:

Function code	Name	Detailed instruction of parameters	Setting range	Default value	Modification	Serial No.
P01.20	Hibernation restore delay time	Setting range: 0.0-3600.0s (valid when P01.19=2)	0.0-3600.0	0.0s	<input type="radio"/>	39
P01.21	Restart after power off	0: disabling 1: enabling	0-1	0	<input type="radio"/>	40

If there is one figure behind the radix point in the setting range or the default value, then the fieldbus ratio value is 10. if the data received by the upper monitor is 50, then the “hibernation restore delay time” is 5.0 ( $5.0=50 \div 10$ ).

If MODBUS communication is used to control the hibernation restore delay time as 5.0s. Firstly, 5.0 can be magnified by 10 times to integer 50 (32H) and then this data can be sent.

01  
inverter address
06  
read command
01 14  
parameters address
00 32  
data number
49 E7  
CRC check

After the inverter receives the command, it will change 50 into 5 according to the fieldbus ratio value and then set the hibernation restore delay time as 5s.

Another example, after the upper monitor sends the command of reading the parameter of hibernation restore delay time ,if the response message of the inverter is as following:

01  
inverter address
03  
read command
02  
2 bytes data
00 32  
parameter data
39 91  
CRC check

Because the parameter data is 0032H (50) and 50 divided by 10 is 5, then the hibernation restore delay time is 5s.

#### 9.4.7 Fault message response

There may be fault in the communication control. For example, some parameter can only be read. If a writing message is sent, the inverter will return a fault response message.

The fault message is from the inverter to the master, its code and meaning is as below:

Code	Name	Meaning
01H	Illegal command	The command from master can not be executed. The reason maybe: 1. This command is only for new version and this version can not realize. 2. Slave is in fault state and can not execute it.
02H	Illegal data address.	Some of the operation addresses are invalid or not allowed to access. Especially the combination of the register and the transmitting bytes are invalid.
03H	Illegal value	When there are invalid data in the message framed received by slave. <b>Note:</b> This error code does not indicate the data value to write exceed the range, but indicate the message frame is an illegal frame.
04H	Operation failed	The parameter setting in parameter writing is invalid. For example, the function input terminal can not be set repeatedly.
05H	Password error	The password written to the password check address is not same as the password set by P7.00.
06H	Data frame error	In the frame message sent by the upper monitor, the length of the digital frame is incorrect or the counting of CRC check bit in RTU is different from the lower monitor.
07H	Written not allowed.	It only happen in write command, the reason maybe: 1. The written data exceeds the parameter range. 2. The parameter should not be modified now. 3. The terminal has already been used.
08H	The parameter can not be	The modified parameter in the writing of the upper monitor can not be modified during running.

Code	Name	Meaning
	changed during running	
09H	Password protection	When the upper monitor is writing or reading and the user password is set without password unlocking, it will report that the system is locked.

The slave uses functional code fields and fault addresses to indicate it is a normal response or some error occurs (named as objection response). For normal responses, the slave shows corresponding function codes, digital address or sub-function codes as the response. For objection responses, the slave returns a code which equals the normal code, but the first byte is logic 1.

For example: when the master sends a message to the slave, requiring it to read a group of address data of the inverter function codes, there will be following function codes:

0 0 0 0 0 1 1 (Hex 03H)

For normal responses, the slave responds the same codes, while for objection responses, it will return:

1 0 0 0 0 1 1 (Hex 83H)

Besides the function codes modification for the objection fault, the slave will respond a byte of abnormal code which defines the error reason.

When the master receives the response for the objection, in a typical processing, it will send the message again or modify the corresponding order.

For example, set the “running command channel” of the inverter (P00.01, parameter address is 0001H) with the address of 01H to 03, the command is as following:

01 06 00 01 00 03 98 0B  
inverter address read parameter address parameter data CRC check

But the setting range of “running command channel” is 0~2, if it is set to 3, because the number is beyond the range, the inverter will return fault response message as below:

01 86 04 43 A3  
inverter address abnormal response code fault code CRC check

Abnormal response code 86H means the abnormal response to writing command 06H; the fault code is 04H. In the table above, its name is operation failed and its meaning is that the parameter setting in parameter writing is invalid. For example, the function input terminal can not be set repeatedly.

### 9.4.8 Example of writing and reading

Refer to 10.4.1 and 10.4.2 for the command format.

#### 9.4.8.1 Example of reading command 03H

Read the state word 1 of the inverter with the address of 01H (refer to table 1). From the table 1, the parameter address of the state word 1 of the inverter is 2100H.

The command sent to the inverter:

01 03 21 00 00 01 8E 36  
inverter address read parameter address data number CRC check

If the response message is as below:

01    03    02    00 03    F8 45  
inverter    read    data    data content    CRC check  
address    command    number

The data content is 0003H. From the table 1, the inverter stops.

Watch “the current fault type” to “the previous 5 times fault type” of the inverter through commands, the corresponding function code is P07.27~P07.32 and corresponding parameter address is 071BH~0720H(there are 6 from 071BH).

The command sent to the inverter:

03    03    07 1B    00 06    B5 59  
inverter    read    start address    total 5 parameters    CRC check  
address    command

If the response message is as below:

03 03 0C 00 23 00 23 00 23 00 23 00 23 00 23 00 23 00 23 5F D2  
inverter    read    byte    current fault    previous    previous 2    previous 3    previous 4    previous 5    CRC check  
address    command       type    fault type    fault type    fault type    fault type    fault type    fault type

See from the returned data, all fault types are 0023H (decimal 35) with the meaning of maladjustment (STo).

#### 9.4.8.2 Example of writing command 06H

Make the inverter with the address of 03H to run forward. See table 1, the address of “communication control command” is 2000H and forward running is 0001. See the table below.

Function instruction	Address definition	Data meaning instruction	FW characteristics
Communication control command	2000H	0001H: forward running	W
		0002H: reverse running	
		0003H: forward jogging	
		0004H: reverse jogging	
		0005H: stop	
		0006H: signal to stop (emergency stop)	
		0007H: fault reset	
		0008H: jogging stop	
		0009H: pre-exciting	

The command sent by the master:

03    06    20 00    00 01    42 28  
inverter    write    parameter    forward running    CRC check  
address    command    address

If the operation is success, the response may be as below (the same with the command sent by the master):

03    06    20 00    00 01    42 28  
inverter    write    parameter    forward running    CRC check  
address    command    address

Set the Max. Output frequency of the inverter with the address of 03H as 100Hz.

P00.03	Max. output frequency	Setting range : P00.04~600.00Hz(400.00 Hz)	10.00~600.00	50.00Hz	⊙	3.
--------	-----------------------	--	--------------	---------	---	----

See the figures behind the radix point, the fieldbus ratio value of the Max. output frequency (P00.03) is 100. 100Hz timed by 100 is 10000 and the corresponding hex is 2710H.

The command sent by the master:

03   06   00 03   27 10   62 14  
inverter   write   parameter   forward   CRC  
address   command   address   running   check

If the operation is successful, the response may be as below (the same with the command sent by the master):

03   06   00 03   27 10   62 14  
inverter   write   parameter   forward   CRC  
address   command   address   running   check

**Note:** the blank in the above command is for illustration. The blank can not be added in the actual application unless the upper monitor can remove the blank by themselves.

**Common communication fault**

Common communication faults are: no response to the communication or the inverter returns abnormal fault.

The possible reason for no response to the communication:

Selecting wrong serial interface, for example, if the converter is COM1, selecting COM2 during the communication

The baud rate, digital bit, end bit and check bit are not the same with the inverter + and - of RS485 are connected in reverse.

The 485 wire cap on the terminal board of the inverter is not plug in. the wire cap in behind the terminal arrangement.

**9.4.8.3 Example of continuous writing command 10H**

Example 1: make the inverter whose address is 01H run forward at 10Hz. Refer to the instruction of 2000H and 0001. Set the address of “communication setting frequency” is 2001H and 10Hz corresponds to 03E8H. See the table below.

Function instruction	Address definition	Data meaning instruction	R/W characteristics
Communication control command	2000H	0001H:forward running	W/R
		0002H:reverse running	
		0003H:forward jogging	
		0004H:reverse jogging	
		0005H:stop	
		0006H:coast to stop (emergency stop)	
		0007H:fault reset	
		0008H:jogging stop	
The address of communication setting	2001H	Communication setting frequency(0~Fmax(unit: 0.01Hz))	W/R
	2002H	PID given, range(0~1000, 1000 corresponds to100.0% )	

Set P00.01 to 2 and P00.06 to 8.

The command sent to the inverter:

01   10   20 00   00 02   04   00 01 03 E8   3B 10  
Inverter   Continuous   Parameters   Data   Byte   Forward   10Hz   CRC  
address   writing   address   number   number   running   check



## Appendix A Technical Data

### A.1 What this chapter contains

This chapter contains the technical specifications of the inverter, as well as provisions for fulfilling the requirements for CE and other marks.

### A.2 Ratings

#### A.2.1 Capacity

Inverter sizing is based on the rated motor current and power. To achieve the rated motor power reference in the table, the rated current of the inverter must be higher than or equal to the rated motor current. Also the rated power of the inverter must be higher than or equal to the rated motor power. The power ratings are the same regardless of the supply voltage within one voltage range.

#### Note:

1. The maximum allowed motor shaft power is limited to  $1.5 \cdot P_N$ . If the limit is exceeded, motor torque and current are automatically restricted. The function protects the input bridge of the drive against overload.
2. The ratings apply at ambient temperature of  $40\text{ }^\circ\text{C}$
3. It is important to check that in Common DC systems the power flowing through the common DC connection does not exceed  $P_N$ .

#### A.2.2 Derating

The load capacity decreases if the installation site ambient temperature exceeds  $40\text{ }^\circ\text{C}$ , the altitude exceeds 1000 meters or the switching frequency is changed from 4 kHz to 8, 12 or 15 kHz.

##### A.2.2.1 Temperature derating

In the temperature range  $+40\text{ }^\circ\text{C} \dots +50\text{ }^\circ\text{C}$ , the rated output current is decreased by 3% for every additional  $1\text{ }^\circ\text{C}$ . Refer to the below list for the actual derating.

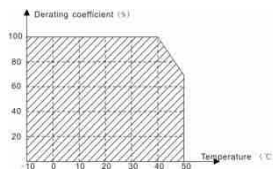

##### A.2.2.2 Altitude derating

The device can output rated power if the installation site below 1000m. The output power decreases if the altitude exceeds 1000 meters. Below is the detailed decreasing range of the derating:

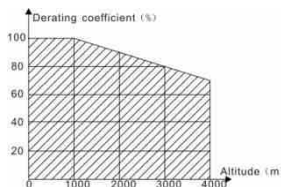

For 3-phase 200 V drives, the maximum altitude is 3000m above sea level. In altitudes 2000...3000 m, the derating is 1% for every 100 m.

#### A.2.2.3 Carrier frequency derating

For MSI200A series inverters, different power level corresponds to different carrier frequency range. The rated power of the inverter is based on the factory carrier frequency, so if it is above the factory value, the inverter needs to derate 20% for every additional 1 kHz carrier frequency.

### A.3 Electric power network specification

Voltage	AC 3PH 220(-15%)~240(+10%) AC 3PH 380(-15%)~440(+10%) AC 3PH 520(-15%)~690(+10%)
Short-circuit capacity	Maximum allowed prospective short-circuit current at the input power connection as defined in IEC 60439-1 is 100 kA. The drive is suitable for use in a circuit capable of delivering not more than 100 kA at the drive maximum rated voltage.
Frequency	50/60 Hz $\pm$ 5%, maximum rate of change 20%/s

### A.4 Motor connection data

Motor type	Asynchronous inductance motor
Voltage	0 to U1, 3-phase symmetrical, U <sub>max</sub> at the field weakening point
Short-circuit protection	The motor output is short-circuit proof by IEC 61800-5-1
Frequency	0...400 Hz
Frequency resolution	0.01 Hz
Current	Refer to Ratings
Power limit	1.5 · PN
Field weakening point	10...400 Hz
Carrier frequency	4, 8, 12 or 15 kHz

#### A.4.1 EMC compatibility and motor cable length

To comply with the European EMC Directive (standard IEC/EN 61800-3), use the following maximum motor cable lengths for 4 kHz switching frequency.

All frame sizes	Maximum motor cable length, 4 kHz
Second environment (category C3)	30
first environment (category C2)	30

Maximum motor cable length is determined by the drive's operational factors. Contact your local MORGENSEN representative for the exact maximum lengths when using external EMC filters.

### A.5 Applicable standards

The inverter complies with the following standards:



EN ISO 13849-1: 2008	Safety of machinery-safety related parts of control systems - Part 1: general principles for design
IEC/EN 60204-1:2006	Safety of machinery. Electrical equipment of machines. Part 1: General requirements.
IEC/EN 62061: 2005	Safety of machinery – Functional safety of safety-related electrical, electronic and programmable electronic control systems
IEC/EN 61800-3:2004	Adjustable speed electrical power drives systems. Part 3: EMC requirements and specific test methods
IEC/EN 61800-5-1:2007	Adjustable speed electrical power drive systems – Part 5-1: Safety requirements – Electrical, thermal and energy
IEC/EN 61800-5-2:2007	Adjustable speed electrical power drive systems – Part 5-2: Safety requirements. Functional.

### A.5.1 CE marking

The CE mark is attached to the drive to verify that the drive follows the provisions of the European Low Voltage (2006/95/EC) and EMC Directives (2004/108/EC).

### A.5.2 Compliance with the European EMC Directive

The EMC Directive defines the requirements for immunity and emissions of electrical equipment used within the European Union. The EMC product standard (EN 61800-3:2004) covers requirements stated for drives. See section *EMC regulations*

### A.6 EMC regulations

EMC product standard (EN 61800-3:2004) contains the EMC requirements to the inverter.

First environment: domestic environment (includes establishments connected to a low-voltage network which supplies buildings used for domestic purposes).

Second environment includes establishments connected to a network not directly supplying domestic premises.

Four categories of the inverter:

Inverter of category C1: inverter of rated voltage less than 1000 V and used in the first environment.

Inverter of category C2: inverter of rated voltage less than 1000 V other than pins, sockets and motion devices and intended to be installed and commissioned only by a professional electrician when used in the first environment.

**Note:** IEC/EN 61800-3 in EMC standard doesn't limit the power distribution of the inverter, but it defines the step, installation and commission. The professional electrician has necessary skills in installing and/or commissioning power drive systems, including their EMC aspects.

Inverter of category C3: inverter of rated voltage less than 1000 V and used in the second environment other than the first one.

Inverter of category C4: inverter of rated voltage more than 1000 V or the rated current is above or equal to 400A and used in the complicated system in second environment.

### A.6.1 Category C2

The emission limits are complied with the following provisions:

1. The optional EMC filter is selected according to the options and installed as specified in the EMC filter manual.
2. The motor and control cables are selected as specified in this manual.
3. The drive is installed according to the instructions reference in this manual.
4. For the maximum motor cable length with 4 kHz switching frequency, see **EMC compatibility and motor cable length**



⚡ **In a domestic environment, this product may cause radio interference, in which case supplementary mitigation measures may be required.**

### A.6.2 Category C3

The immunity performance of the drive complies with the demands of IEC/EN 61800-3, second environment.

The emission limits are complied with the following provisions:

1. The optional EMC filter is selected according to the options and installed as specified in the EMC filter manual.
2. The motor and control cables are selected as specified in this manual.
3. The drive is installed according to the instructions reference in this manual.
4. For the maximum motor cable length with 4 kHz switching frequency, see **EMC compatibility and motor cable length**



⚡ **A drive of category C3 is not intended to be used on a low-voltage public network which supplies domestic premises. Radio frequency interference is expected if the drive is used on such a network.**

## Appendix B Dimension Drawings

### B.1 What this chapter contains

Dimension drawings of the MSI200A are shown below. The dimensions are reference in millimeters and inches.

### B.2 Keypad structure

#### B.2.1 Structure chart

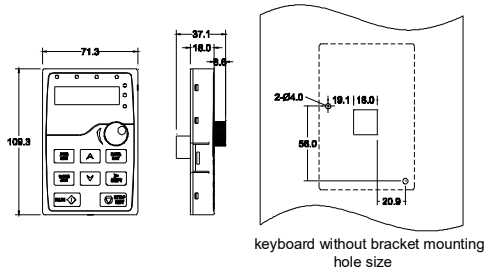

#### B.2.2 Installation chart

Note: The external keypad can be fix by M3 screws directly or the installation bracket. The installation bracket for inverters of 0.75~30kW is optional and the installaion bracket for inverters of 37~500kW is optional or substitutive by the external standard one.

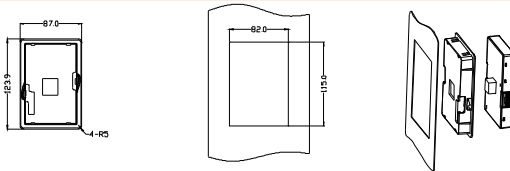

Installation bracket of the key (0.75~500kW)(optional)

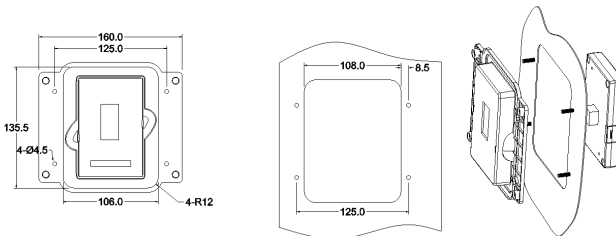

Installation bracket of the key (37~500kW)(standard)

## B.3 Inverter chart

### B.3.1 Wall mounting

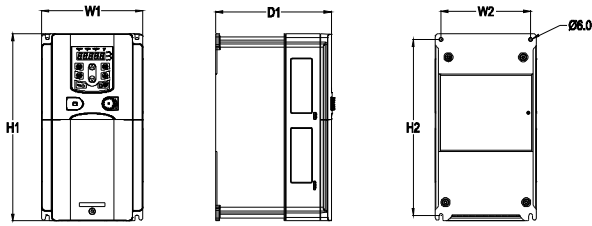

0.75-15kW wall mounting

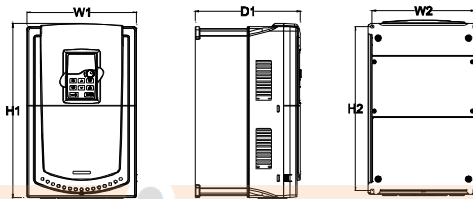

18.5-30kW wall mounting

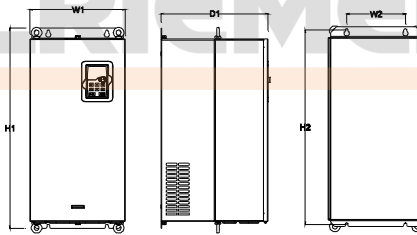

37-110kW wall mounting

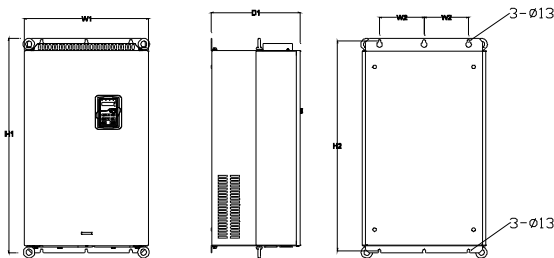

132-200kW wall mounting

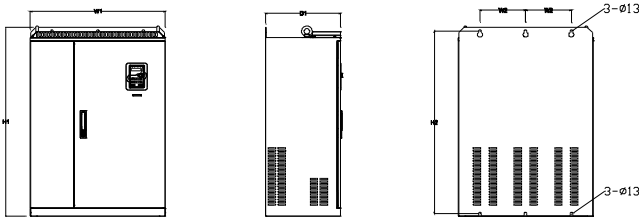

220-315kW wall mounting  
Installation dimension (unit: mm)

Model	W1	W2	H1	H2	D1	Installation hole
0.75kW ~2.2kW	126	115	186	175	174.5	5
4kW~5.5kW	146	131	256	243.5	181	6
7.5kW~15kW	170	151	320	303.5	216	6
18.5kW	230	210	342	311	216	6
22kW~30kW	255	237	407	384	245	7
37kW~55kW	270	130	555	540	325	7
75kW~110kW	325	200	680	661	365	9.5
132kW~200kW	500	180	870	850	360	11
220kW~315kW	680	230	960	926	379.5	13

**B.3.2 Flange mounting**

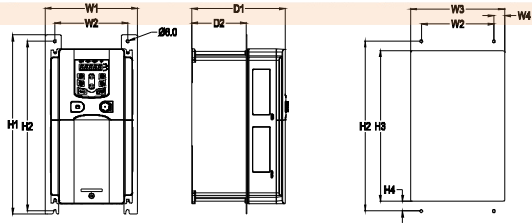

0.75-15kW flange mounting

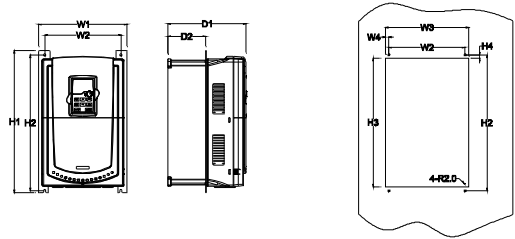

18.5-30kW flange mounting

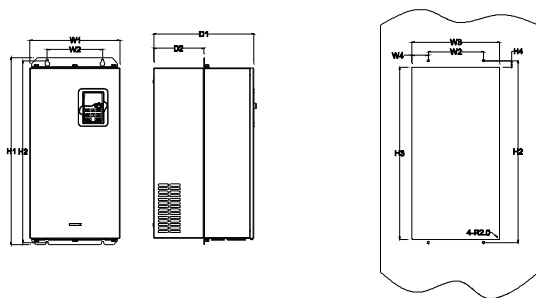

37-110kW flange mounting

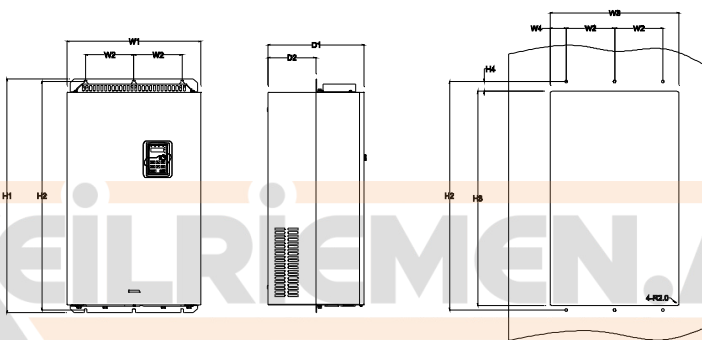

132-200kW flange mounting

Installation dimension (unit: mm)

Model	W1	W2	W3	W4	H1	H2	H3	H4	D1	D2	Installation hole
0.75kW~2.2kW	150.2	115	130	7.5	234	220	190	13.5	155	65.5	5
4kW~5.5kW	170.2	131	150	9.5	292	276	260	6	167	84.5	6
7.5kW~15kW	191.2	151	174	11.5	370	351	324	12	196.3	113	6
18.5kW	250	210	234	12	375	356	334	10	216	108	6
22kW~30kW	275	237	259	11	445	426	404	10	245	119	7
37kW~55kW	270	130	261	65.5	555	540	516	17	325	167	7
75kW~110kW	325	200	317	58.5	680	661	626	23	363	182	9.5
132kW~200kW	500	180	480	60	870	850	796	37	358	178.5	11

### B.3.3 Floor mounting

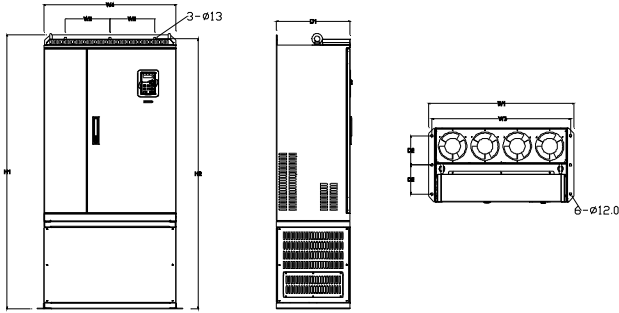

220-315kW floor mounting

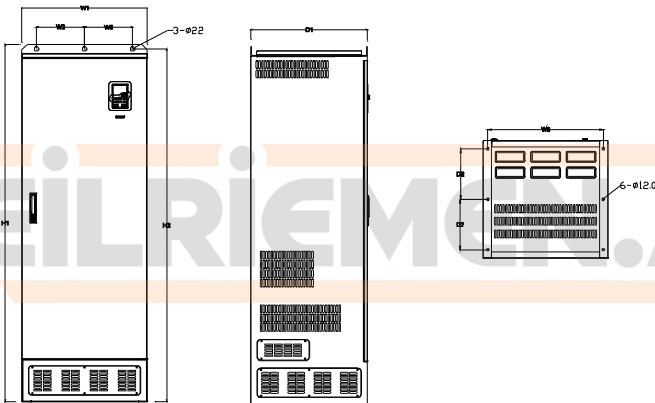

50-500kW floor mounting

Model	W1	W2	W3	W4	H1	H2	D1	D2	Installation hole
220kW~315kW	750	230	714	680	1410	1390	380	150	13\12
350kW~500kW	620	230	573	\	1700	1678	560	240	22\12

## Appendix C Peripheral Options and Parts

### C.1 What this chapter contains

This chapter describes how to select the options and parts of MSI200A series.

### C.2 Peripheral wiring

Below is the peripheral wiring of MSI200A series inverters.

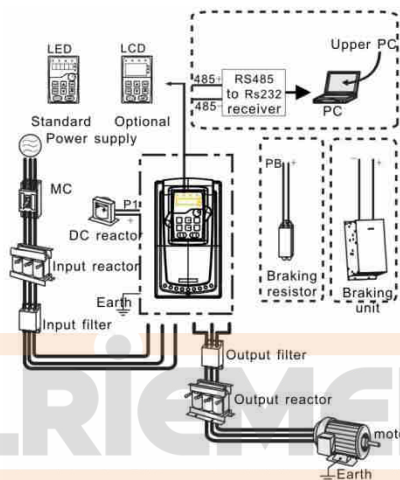





#### Note:

1. The inverters ( $\leq 15\text{kW}$ ) have standard film keypad and the inverters ( $\geq 18.5\text{kW}$ ) have standard LED keypad.
2. The inverter below  $30\text{kW}$  (including  $30\text{kW}$ ) are embedded with braking unit.
3. Only the inverter above  $37\text{kW}$  (including  $37\text{kW}$ ) have P1 terminal and are connected with DC reactors.
4. The braking units apply standard braking unit DBU series in. Refer to the instruction of DBU for detailed information.

Pictures	Name	Descriptions
	Cables	Device to transfer the electronic signals
	Breaker	Prevent from electric shock and protect the power supply and the cables system from overcurrent when short circuits occur. (Please select the breaker with the function of reducing high order harmonic and the rated sensitive current to 1 inverter should be above $30\text{mA}$ ).

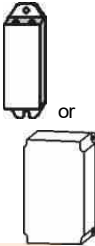

Pictures	Name	Descriptions
	Input reactor	This device is used to improve the power factor of the input side of the inverter and control the higher harmonic current.
	DC reactor	The inverter above 37kW (including 37kW) can be connected with DC reactor.
	Input filter	Control the electromagnetic interference generated from the inverter, please install close to the input terminal side of the inverter.
	Braking unit or resistors	Shorten the DEC time The inverters below 30kW(including 30kW) only need braking resistors and the inverters above 37kW(including 37 kW) need braking units
	Output filter	Control the interference from the output side of the inverter and please install close to the output terminals of the inverter.
	Output reactor	Prolong the effective transmitting distance of the inverter to control the sudden high voltage when switching on/off the IGBT of the inverter.

### C.3 Power supply

Please refer to **Electronical Installation**.

	<p>❖ Check that the voltage degree of the inverter complies with the voltage of the supply power voltage.</p>
---	---

### C.4 Cables

#### C.4.1 Power cables

Dimension the input power and motor cables according to local regulations.

- The input power and the motor cables must be able to carry the corresponding load currents.
- The cable must be rated for at least 70 °C maximum permissible temperature of the conductor in continuous use.
- The conductivity of the PE conductor must be equal to that of the phase conductor (same cross-sectional area).
- Refer to chapter **Technical Data** for the EMC requirements.

A symmetrical shielded motor cable (see the figure below) must be used to meet the EMC requirements of the CE.

A four-conductor system is allowed for input cabling, but a shielded symmetrical cable is recommended. Compared to a four-conductor system, the use of a symmetrical shielded cable reduces electromagnetic emission of the whole drive system as well as motor bearing currents and wear.

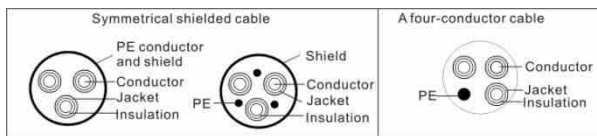

**Note:** A separate PE conductor is required if the conductivity of the cable shield is not sufficient for the purpose.

To function as a protective conductor, the shield must have the same cross-sectional area as the phase conductors when they are made of the same metal.

To effectively suppress radiated and conducted radio-frequency emissions, the shield conductivity must be at least 1/10 of the phase conductor conductivity. The requirements are easily met with a copper or aluminum shield. The minimum requirement of the motor cable shield of the drive is shown below. It consists of a concentric layer of copper wires. The better and tighter the shield, the lower the emission level and bearing currents.

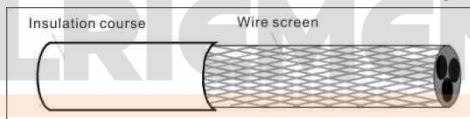

### C.4.2 Control cables

All analog control cables and the cable used for the frequency input must be shielded. Use a double-shielded twisted pair cable (Figure a) for analog signals. Employ one individually shielded pair for each signal. Do not use common return for different analog signals.

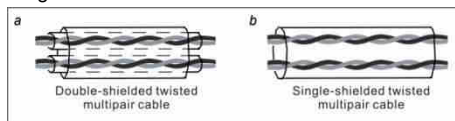

A double-shielded cable is the best alternative for low-voltage digital signals, but a single-shielded or unshielded twisted multi-pair cable (Figure b) is also usable. However, for frequency input, always use a shielded cable.

The relay cable needs the cable type with braided metallic screen.

The keypad needs to connect with cables. It is recommended to use the screen cable on complex electrical magnetic condition.

**Note: Run analog and digital signals in separate cables.**

Do not make any voltage tolerance or insulation resistance tests (for example hi-pot or megger) on any part of the drive as testing can damage the drive. Every drive has been tested for insulation between the main circuit and the chassis at the factory. Also, there are

voltage-limiting circuits inside the drive which cut down the testing voltage automatically. Check the insulation of the input power cable according to local regulations before connecting to the drive.

**Note: Check the insulation of the input power cables according to local regulations before connecting the cables.**

The inverter	Recommended cable size(mm <sup>2</sup> )				Screw	
	R,S,T U,V,W	PE	P1(+)	PB(+)(-)	Terminal screw size	Tightening torque (Nm)
MSI200A -0R7G-4	2.5	2.5	2.5	2.5	M4	1.2~1.5
MSI200A -1R5G-4	2.5	2.5	2.5	2.5	M4	1.2~1.5
MSI200A -2R2G-4	2.5	2.5	2.5	2.5	M4	1.2~1.5
MSI200A -004G/5R5P-4	2.5	2.5	2.5	2.5	M4	1.2~1.5
MSI200A -5R5G/7R5P-4	4	4	2.5	2.5	M5	2~2.5
MSI200A -7R5G/011P-4	6	6	4	2.5	M5	2~2.5
MSI200A -011G/015P-4	10	10	6	4	M5	2~2.5
MSI200A -015G/018P-4	10	10	10	4	M5	2~2.5
MSI200A -018G/022P-4	16	16	10	6	M6	4~6
MSI200A -022G/030P-4	25	16	16	10	M6	4~6
MSI200A -030G/037P-4	25	16	16	10	M8	9~11
MSI200A -037G/045P-4	35	16	25	16	M8	9~11
MSI200A -045G/055P-4	50	25	35	25	M8	9~11
MSI200A -055G/075P-4	70	35	50	25	M10	18~23
MSI200A -075G/090P-4	95	50	70	35	M10	18~23
MSI200A -090G/110P-4	120	70	95	35	M10	18~23
MSI200A -110G/132P-4	150	70	120	70	M12	31~40
MSI200A -132G/160P-4	185	95	150	95	M12	31~40
MSI200A -160G/185P-4	240	95	185	50	M12	31~40
MSI200A -185G/200P-4	120*2P	150	95*2P	50	M12	31~40
MSI200A -200G/220P-4	120*2P	150	95*2P	50	M12	31~40
MSI200A -220G/250P-4	150*2P	150	95*2P	50	M12	31~40
MSI200A -250G/280P-4	150*2P	150	120*2P	95	M12	31~40
MSI200A -280G/315P-4	185*2P	185	120*2P	95	M12	31~40
MSI200A -315G/350P-4	185*2P	185	120*2P	95	M12	31~40
MSI200A -350G/400P-4	95*4P	95*2P	150*2P	120	M12	31~40
MSI200A -400G-4	95*4P	95*2P	150*2P	120	M12	31~40
MSI200A -500G-4	120*4P	95*2P	95*4P	120	M12	31~40

**Note:**

1. It is appropriate to use the recommended cable size under 40°C and rated current. The wiring distance should be no more than 100m.
2. Terminals P1, (+), PB and (-) connects the DC reactor options and parts.

### C.4.3 Routing the cables

Route the motor cable away from other cable routes. Motor cables of several drives can be run in parallel installed next to each other. It is recommended that the motor cable, input power cable and control cables are installed on separate trays. Avoid long parallel runs of motor cables with other cables to decrease electromagnetic interference caused by the rapid changes in the drive output voltage.

Where control cables must cross power cables make sure that they are arranged at an angle as near to 90 degrees as possible.

The cable trays must have good electrical bonding to each other and to the grounding electrodes. Aluminum tray systems can be used to improve local equalizing of potential.

A figure of the cable routing is shown below.

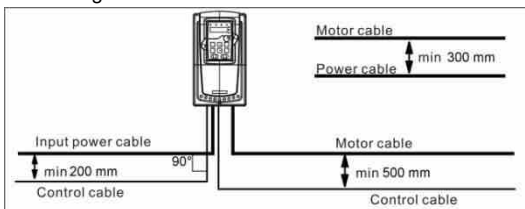

### C.4.4 Checking the insulation

Check the insulation of the motor and motor cable as follows:

1. Check that the motor cable is connected to the motor and disconnected from the drive output terminals U, V and W.
2. Measure the insulation resistance between each phase conductor and the Protective Earth conductor using a measuring voltage of 500 V DC. For the insulation resistance of other motors, please consult the manufacturer's instructions.

**Note:** Moisture inside the motor casing will reduce the insulation resistance. If moisture is suspected, dry the motor and repeat the measurement.

## C.5 Breaker, electromagnetic contactor and leakage protection switch

Due to the inverter output high frequency PWM voltage waveform, and the existence of distributed capacitance between IGBT and heatsink in internal inverter and the distributed capacitance between motor stator and rotor will cause the inverter inevitably generate high-frequency leakage current to ground. The high-frequency leakage current will back flow to grid through the earth to interference the leakage protection switch, thus causing the leakage protection switch malfunction. This is due to the inverter output voltage characteristics inherent in the decision.

To ensure the stability of the system, it is recommended to use the inverter dedicated leakage protection switch which rated residual operation current 30mA or more (for example, corresponds to IEC60755 Type B). If you are not using the inverter dedicated leakage protection switch caused by malfunction, try to reduce the carrier frequency, or replace the electromagnetic leakage protection switch which rated residual operating current of 200mA or more.

It is necessary to add fuse for the avoidance of overload.

It is appropriate to use a breaker (MCCB) which complies with the inverter power in the 3-phase AC power and input power and terminals (R, S and T). The capacity of the inverter should be 1.5-2 times of the rated current.

	<p>⚡ <b>Due to the inherent operating principle and construction of circuit breakers, independent of the manufacturer, hot ionized gases may escape from the breaker enclosure in case of a short-circuit. To ensure safe use, special attention must be paid to the installation and placement of the breakers. Follow the manufacturer's instructions.</b></p>
---	--

Inverter	Breaker (A)	Fuse (A)	Rated current of the reactor (A)
MSI200-0R7G-4	10	16	12
MSI200-1R5G-4	10	16	12
MSI200-2R2G-4	16	16	12
MSI200-004G/5R5P-4	16	25	12
MSI200-5R5G/7R5P-4	25	32	25
MSI200-7R5G/011P-4	40	40	25
MSI200-011G/015P-4	50	50	40
MSI200-015G/018P-4	63	63	40
MSI200-018G/022P-4	63	80	50
MSI200-022G/030P-4	80	100	65
MSI200-030G/037P-4	100	125	80
MSI200-037G/045P-4	125	160	95
MSI200-045G/055P-4	160	160	115
MSI200-055G/075P-4	160	200	150
MSI200-075G/090P-4	250	250	185
MSI200-090G/110P-4	250	315	225
MSI200-110G/132P-4	315	315	265
MSI200-132G/160P-4	350	400	330
MSI200-160G/185P-4	400	500	400
MSI200-185G/200P-4	500	630	500
MSI200-200G/220P-4	500	630	500
MSI200-220G/250P-4	630	630	500
MSI200-250G/280P-4	630	800	630
MSI200-280G/315P-4	700	800	630
MSI200-315G/350P-4	800	1000	780
MSI200-350G/400P-4	800	1000	780
MSI200-400G-4	1000	1250	780
MSI200-500G-4	1200	1250	980

## C.6 Reactors

If the distance between the inverter and the motor is longer than 50m, frequent overcurrent protection may occur to the inverter because of high leakage current caused by parasitic capacitance effects from the long cables to the ground. In order to avoid the damage of the motor insulation, it is necessary to add reactor compensation.

The power of the inverter	Input reactor	DC reactor	Output reactor
MSI200A -0R7G-4	ACL2-1R5-4	/	OCL2-1R5-4
MSI200A -1R5G-4	ACL2-1R5-4	/	OCL2-1R5-4
MSI200A -2R2G-4	ACL2-2R2-4	/	OCL2-2R2-4
MSI200A -004G/5R5P-4	ACL2-004-4	/	OCL2-004-4
MSI200A -5R5G/7R5P-4	ACL2-5R5-4	/	OCL2-5R5-4
MSI200A -7R5G/011P-4	ACL2-7R5-4	/	OCL2-7R5-4
MSI200A -011G/015P-4	ACL2-011-4	/	OCL2-011-4
MSI200A -015G/018P-4	ACL2-015-4	/	OCL2-015-4
MSI200A -018G/022P-4	ACL2-018-4	/	OCL2-018-4
MSI200A -022G/030P-4	ACL2-022-4	/	OCL2-022-4
MSI200A -030G/037P-4	ACL2-030-4	/	OCL2-030-4
MSI200A -037G/045P-4	ACL2-037-4	DCL2-037-4	OCL2-037-4
MSI200A -045G/055P-4	ACL2-045-4	DCL2-045-4	OCL2-045-4
MSI200A -055G/075P-4	ACL2-055-4	DCL2-055-4	OCL2-055-4
MSI200A -075G/090P-4	ACL2-075-4	DCL2-075-4	OCL2-075-4
MSI200A -090G/110P-4	ACL2-090-4	DCL2-090-4	OCL2-090-4
MSI200A -110G/132P-4	ACL2-110-4	DCL2-110-4	OCL2-110-4
MSI200A -132G/160P-4	ACL2-132-4	DCL2-132-4	OCL2-132-4
MSI200A -160G/185P-4	ACL2-160-4	DCL2-160-4	OCL2-160-4
MSI200A -185G/200P-4	ACL2-200-4	DCL2-200-4	OCL2-200-4
MSI200A -200G/220P-4	ACL2-200-4	DCL2-200-4	OCL2-200-4
MSI200A -220G/250P-4	ACL2-250-4	DCL2-250-4	OCL2-250-4
MSI200A -250G/280P-4	ACL2-250-4	DCL2-250-4	OCL2-250-4
MSI200A -280G/315P-4	ACL2-280-4	DCL2-280-4	OCL2-280-4
MSI200A -315G/350P-4	ACL2-315-4	DCL2-315-4	OCL2-315-4
MSI200A -350G/400P-4	Standard	DCL2-350-4	OCL2-350-4
MSI200A -400G-4	Standard	DCL2-400-4	OCL2-400-4
MSI200A -500G-4	Standard	DCL2-500-4	OCL2-500-4

### Note:

1. The rated derate voltage of the input reactor is 2%±15%.
2. The power factor of the input side is above 90% after adding DC reactor.
3. The rated derate voltage of the output reactor is 1%±15%.
4. Above options are external, the customer should indicate when purchasing.

## C.7 Filters

The inverter	Input filter	Output filter
MSI200A -0R7G-4	FLT-P04006L-B	FLT-L04006L-B
MSI200A -1R5G-4		
MSI200A -2R2G-4		
MSI200A -004G/5R5P-4	FLT-P04016L-B	FLT-L04016L-B
MSI200A -5R5G/7R5P-4		
MSI200A -7R5G/011P-4	FLT-P04032L-B	FLT-L04032L-B
MSI200A -011G/015P-4		
MSI200A -015G/018P-4	FLT-P04045L-B	FLT-L04045L-B
MSI200A -018G/022P-4		
MSI200A -022G/030P-4	FLT-P04065L-B	FLT-L04065L-B
MSI200A -030G/037P-4		
MSI200A -037G/045P-4	FLT-P04100L-B	FLT-L04100L-B
MSI200A -045G/055P-4		
MSI200A -055G/075P-4	FLT-P04150L-B	FLT-L04150L-B
MSI200A -075G/090P-4		
MSI200A -090G/110P-4	FLT-P04240L-B	FLT-L04240L-B
MSI200A -110G/132P-4		
MSI200A -132G/160P-4		
MSI200A -160G/185P-4	FLT-P04400L-B	FLT-L04400L-B
MSI200A -185G/200P-4		
MSI200A -200G/220P-4	FLT-P04600L-B	FLT-L04600L-B
MSI200A -220G/250P-4		
MSI200A -250G/280P-4		
MSI200A -280G/315P-4	FLT-P04800L-B	FLT-L04800L-B
MSI200A -315G/350P-4		
MSI200A -350G/400P-4		
MSI200A -400G-4	FLT-P041000L-B	FLT-L041000L-B
MSI200A -500G-4		

**Note:** The input EMI meet the requirement of C2 after adding input filters.

## C.8 Braking system

### C.8.1 Select the braking components

It is appropriate to use braking resistor or braking unit when the motor brakes sharply or the motor is driven by a high inertia load. The motor will become a generator if its actual rotating speed is higher than the corresponding speed of the reference frequency. As a result, the inertial energy of the motor and load return to the inverter to charge the capacitors in the main DC circuit. When the voltage increases to the limit, damage may occur to the inverter. It is necessary to apply braking unit/resistor to avoid this accident happens.

	<ul style="list-style-type: none"> <li>✧ Only qualified electricians are allowed to design, install, commission and operate on the inverter.</li> <li>✧ Follow the instructions in “warning” during working. Physical injury or death or serious property may occur.</li> <li>✧ Only qualified electricians are allowed to wire. Damage to the inverter or braking options and part may occur. Read carefully the instructions of braking resistors or units before connecting them with the inverter.</li> <li>✧ Do not connect the braking resistor with other terminals except for PB and (-). Do not connect the braking unit with other terminals except for (+) and (-). Damage to the inverter or braking circuit or fire may occur.</li> </ul>
	<ul style="list-style-type: none"> <li>✧ Connect the braking resistor or braking unit with the inverter according to the diagram. Incorrect wiring may cause damage to the inverter or other devices.</li> </ul>

MSI200A series inverters below 30kW (including 30kW) need internal braking units and the inverters above 37kW need external braking unit. Please select the resistance and power of the braking resistors according to actual utilization.

**Note:**

Select the resistor and power according to the provided data.

The braking torque may increase because of the raising of braking resistor. The below table is calculated at 100% of the braking torque, 10%, 50% and 80% of the braking usage ratio. The user can select according to the actual working.

Refer to the operation instructions of braking units when using external units for right setting of voltage degree. Otherwise normal operation of the inverter may be impacted.

The inverter	Braking unit type	100% of braking rate (Ω)	The consumed power of the braking resistor			Mini Braking Resistor (Ω)
			10% braking	50% braking	80% braking	
MSI200A -0R7G-4	Internal braking unit	653	0.1	0.6	0.9	240
MSI200A -1R5G-4		326	0.23	1.1	1.8	170
MSI200A -2R2G-4		222	0.33	1.7	2.6	130
MSI200A-004G/5R5P-4		122	0.6	3	4.8	80
MSI200A-5R5G/7R5P-4		89	0.75	4.1	6.6	60
MSI200A -7R5G/011P-4		65	1.1	5.6	9	47
MSI200A -011G/015P-4		44	1.7	8.3	13.2	31
MSI200A -015G/018P-4		32	2	11	18	23
MSI200A -018G/022P-4		27	3	14	22	19
MSI200A -022G/030P-4		22	3	17	26	17
MSI200A -030G/037P-4		16	5	23	36	17
MSI200A -037G/045P-4		DBU100H-060-4	13	6	28	44
MSI200A -045G/055P-4	DBU100H-110-4	10	7	34	54	6.4
MSI200A -055G/075P-4		8	8	41	66	
MSI200A -075G/090P-4		6.5	11	56	90	
MSI200A -090G/110P-4		5.4	14	68	108	



The inverter	Braking unit type	100% of braking rate (Ω)	The consumed power of the braking resistor			Mini Braking Resistor (Ω)
			10% braking	50% braking	80% braking	
MSI200A -110G/132P-4		4.5	17	83	132	
MSI200A -132G/160P-4	DBU100H-220-4	3.7	20	99	158	3.2
MSI200A -160G/185P-4		3.1	24	120	192	2.2
MSI200A -185G/200P-4	DBU100H-320-4	2.8	28	139	222	
MSI200A -200G/220P-4		2.5	30	150	240	
MSI200A -220G/250P-4		2.2	33	165	264	1.8
MSI200A -250G/280P-4	DBU100H-400-4	2.0	38	188	300	
MSI200A -280G/315P-4		3.6*2	21*2	105*2	168*2	2.2*2
MSI200A -315G/350P-4	Two	3.2*2	24*2	118*2	189*2	
MSI200A -350G/400P-4	DBU100H-320-4	2.8*2	27*2	132*2	210*2	
MSI200A -400G-4		2.4*2	30*2	150*2	240*2	
MSI200A -500G-4	Two DBU100H-400-4	2*2	38*2	186*2	300*2	1.8*2

	⚡ Never use a brake resistor with a resistance below the minimum value specified for the particular drive. The drive and the internal chopper are not able to handle the overcurrent caused by the low resistance.
	⚡ Increase the power of the braking resistor properly in the frequent braking situation (the frequency usage ratio is more than 10%).

### C.8.2 Select the brake resistor cables

Use a shielded cable to the resistor cable.

### C.8.3 Place the brake resistor

Install all resistors in a place where they will cool.

	⚡ The materials near the brake resistor must be non-flammable. The surface temperature of the resistor is high. Air flowing from the resistor is of hundreds of degrees Celsius. Protect the resistor against contact.
--	--

Installation of the braking resistor:

	⚡ The inverters below 30kW (including 30kW) only needs external braking resistors.
	⚡ PB and (+) are the wiring terminals of the braking resistors.

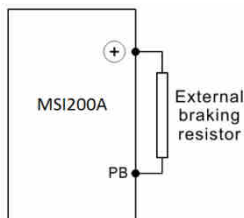

Installation of braking units:



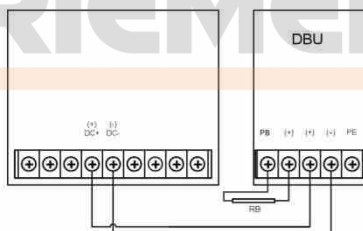

	<ul style="list-style-type: none"> <li>◇ The inverters above 37kW (including 370kW) only needs external braking units.</li> <li>◇ (+), (-) are the wiring terminals of the braking units.</li> <li>◇ The wiring length between the (+),(-) terminals of the inverter and the (+),(-) terminals of the braking units should be no more than 5m, and the distributing length among BR1 and BR2 and the braking resistor terminals should be no more than 10m.</li> </ul>
--	--

Signal installation is as below:



### C.9 Other optional parts

No.	Optional part	Instruction	Picture
1	Flange installation bracket	Needed for the flange installation of 1.5~30kW inverters Not needed for the flange installation of 37~200kW inverters	
2	Installation base	Optimal for 220~315kW inverters An input AC/DC reactor and output AC reactor can be put in the base.	

No.	Optional part	Instruction	Picture
3	Installation bracket	Use the screw or installation bracket to fix the external keypad. Optimal for 1.5~30kW inverters and standard for 37~500kW inverters	
4	Side cover	Protect the internal circuit in serious environment. Derate when selecting the cover. Please contact MORGENSEN for detailed information.	
5	LCD Keypad	Support several languages, parameters copy, high-definition display and the installation dimension is compatible with the LED keypad.	
6	LED keypad	0.75~15kW inverter optional.	

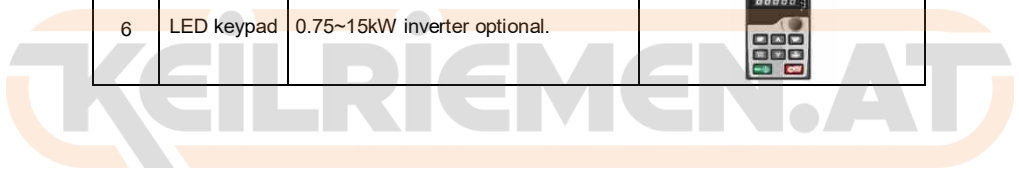

## Appendix D Further Information

---

### D.1 Product and service inquire

Address any inquiries about the product to your local MORGENSEN offices, quoting the type designation and serial number of the unit in question. A listing of MORGENSEN sales, support and service contacts can be found by navigating to [www.morgensen.de](http://www.morgensen.de).

### D.2 Feedback on MORGENSEN inverters manuals

Your comments on our manuals are welcome. Go to [www.morgensen.de](http://www.morgensen.de) and select *Online Feedback* or *Contact Us*.

### D.3 Document library on the internet

You can find manuals and other product documents in PDF format on the Internet. Go to [www.morgensen.de](http://www.morgensen.de) and select *Service and Support of Document Download*.

 KEILRIEMEN.AT

**KEILRIEMEN.AT**

**KEILRIEMEN.AT**

**KEILRIEMEN.AT**

  
**KEILRIEMEN.AT**